



Tribute™ Child Restraint System

Owner's Manual

Keep for future use.

Rear-facing

2.3 to 18 kg
(5 to 40 lbs)

48 to 94cm
(19 to 37 in.)

Forward-facing

10 to 18 kg
(22 to 40 lbs)

71 to 102 cm
(28 to 40 in.)

Para instrucciones en Español,
llamar al: 1-800-233-5921.

! WARNING:

To reduce the risk of serious injury
or death, read this owner's manual prior
to installing and using this child restraint.

More children are killed every year as passengers in car crashes than by any other type of injury. To reduce the risk of **SERIOUS INJURY** or **DEATH**, read this owner’s manual and your vehicle owner’s manual before installing and using this child restraint. Using a child restraint makes a big difference. By properly using this child restraint and following these instructions (and the instructions that accompany your vehicle), you will greatly reduce the risk of serious injury or death to your child from a crash. Do not be misled by the commonly used term “safety seat;” no restraint system can prevent all injuries in all crashes. Many properly restrained adults and children are injured in motor vehicle crashes, including relatively minor crashes. A properly used child restraint is the best way to minimize injuries to your child and to increase the chances for your child’s survival in most crashes.

Table of Contents

Warnings	2
Safe Practices	9
Recall Information for U.S. Customers.....	10
Public Notice for Canadian Customers.....	10
Motor Vehicle/Aircraft Usage	10
Storing Your Instructions.....	11
Symbol Legend.....	11
Visual Glossary	12
Securing Your Child in the Child Restraint	14
Removing Your Child from the Child Restraint	15
Using the Tribute™ Rear-facing.....	16
Positioning the Recline Stand.....	18
Installing with Lower Anchor Connectors	19
Installing with a Seat Belt.....	23
Using the Tribute™ Forward-facing	26
Positioning the Recline Stand.....	28
Installing with the Lower Anchor Connectors.....	29
Installing with a Seat Belt.....	33
Positioning the Harness Strap	37
Adjusting the Crotch Strap	39
Adjusting the Harness Strap	39
Removing the Tether Strap	40
Removing the Lower Anchor Connectors	41
Installing the Accessories.....	42
Care and Cleaning	43
Securing Your Child Restraint in Aircraft	44
Installing Child Restraint Rear-Facing in Aircraft	44
Installing Child Restraint Forward-Facing in Aircraft	47
Replacement Parts	49
Limited Warranty	50

U.S. REGULATORY NOTICE

This child restraint meets all applicable requirements of Federal Motor Vehicle Safety Standard 213.

CANADIAN REGULATORY NOTICE (Model numbers ending in “C.”)

This child restraint meets all applicable requirements of Canadian Motor Vehicle Safety Standards CMVSS 213 and 213.1.

Child Requirements

- *No restraint can guarantee absolute protection from injury in every crash.*
- *This child restraint is designed for use by children in rear-facing and forward-facing positions. To use this child restraint properly, children **MUST** meet weight/size specifications as follows:*

For Rear-facing Use

- The child weighs 2.3 – 18 kg (5 – 40 lbs)
- The child is 48 – 94 cm (19 – 37 inches) **AND** the top of child’s head is at least 25 mm (1 in.) **below the top** of the child restraint seat back.

The American Academy of Pediatrics recommends that children ride in the rear-facing position to the highest weight or height allowed by the child restraint.

For Forward-facing Use

- The child weighs 10 – 18 kg (22 – 40 lbs)
- The child is 71 to 102 cm (28 to 40 inches) **AND** the tops of the child’s ears are below the top of the child restraint seat back.
- Child is one year old or older

Note: Once your child **exceeds** 18 kg (40 lbs) **OR** is **taller** than 102 cm (40 in.), they can no longer safely use this child restraint, and you should consider using a booster seat.

⚠ WARNING

Air Bag Warnings

Rear-facing and Forward-facing Use

- **DO NOT** use this child restraint in the front seat of a vehicle equipped with an air bag, unless the air bag has been deactivated. Interaction between a rear-facing restraint and air bags may cause serious injury or death. Air bags may cause serious injury or death to children 12 and under.

If your vehicle has an air bag, refer to your vehicle owner's manual for child restraint installation.

- If the rear seat of your vehicle is equipped with side air bags, refer to the following information for proper usage.

Vehicles built prior to the 2002 model year:

DO NOT use this restraint in a vehicle seating position equipped with a side air bag unless authorized by the vehicle manufacturer.

Model year 2002 and newer vehicles:

Refer to your vehicle owner's manual before placing this restraint in a seating position equipped with a side air bag.

DO NOT place any objects between the restraint and the side air bag, as an expanding air bag may cause the items to strike the child.



⚠ WARNING

General Warnings

Rear-facing and Forward-facing Use

- Failure to follow installation instructions can result in the child striking the vehicle's interior during a sudden stop or crash. Serious injury or death may result. These instructions and the instructions in your vehicle owner's manual must be followed carefully. If there is a conflict between the two, the vehicle owner's manual regarding child restraint installation must be followed.
- **NEVER** leave child unattended.
- Children have **STRANGL**ED in loose or partially buckled harness straps. Fully restrain the child.

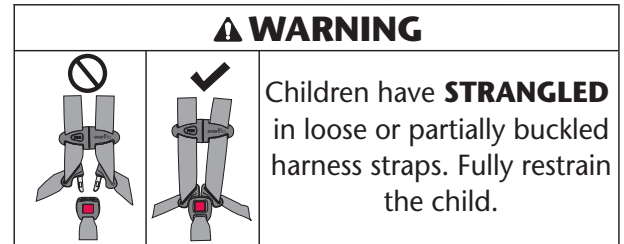

- **DO NOT** use child restraint if it is damaged, broken, or missing parts.
- **DO NOT** use this restraint if it has been involved in a crash. It must be replaced.

Location Warnings

Rear-facing, Forward-facing Use

- **ALWAYS** read and follow exactly the instructions that accompany your vehicle and child restraint.
- According to statistics, children are safer when properly restrained in a rear seating position than in the front seating position. Generally, the center rear position is safest and should be used if available.
- Some child restraints do not fit all vehicles or all seating locations. There are many thousands of combinations of vehicle makes, models, child restraint configurations, vehicle seat belt designs, and seat cushion shapes. The easiest way to determine whether your child restraint is suitable for a particular seating position is to check for a tight installation.

⚠ WARNING

Location Warnings – cont.

Rear-facing and Forward-facing Use

If the child restraint cannot be properly installed, **DO NOT** use the child restraint. Consult vehicle owner's manual, try a different seating location, or call Evenflo for further assistance.

- **ONLY** use this child restraint on **forward-facing vehicle seats**. **DO NOT** use this restraint with vehicle seats that face the rear or side.
- **ONLY** use this child restraint on vehicle seats with backs that lock into place.

Premature Infants

Rear-facing and Forward-facing Use

- **DO NOT** use this or any child restraint with a premature infant until after consulting your doctor. Premature infants may have difficulty breathing when in a seated or semi-reclined position. Using additional padding or pillows behind the infant's head or failing to properly recline the child restraint could increase the child's risk of serious injury or death.

Rear-facing Position Warnings

Rear-facing Use Only

- **DO NOT** use this child restraint rear-facing in a vehicle equipped with lap belts that only lock during a sudden stop or crash (emergency locking retractor – ELR). You must use a seating location with a locking seat belt. Check your vehicle owner's manual to see if you have lap belts with ELRs.
- When using this restraint rear-facing, **DO NOT** loosen the vehicle seat belt to provide more leg room, as this will prevent the child restraint from protecting the child.
- **DO NOT** use the highest set of harness slots rear-facing. The harness will not properly restrain the child during a crash.
- Fold-down armrests could pose a hazard to a rear-facing child in certain types of collisions. Consult your vehicle owner's manual before installing any rear-facing child restraint in front of a fold-down armrest.
- **NEVER** turn a child restraint forward-facing with an infant who weighs less than 10 kg (22 lbs) or is less than one year of age. Crash forces may cause serious injury or death.

⚠ WARNING

Rear-facing Position Warnings

Rear-facing Use Only

- **DO NOT** use the tether strap when the child restraint is in the rear-facing position.
- The headrest on the vehicle seat that the child faces when sitting in the rear-facing mode should be placed in the lowest position. The vehicle seat back that the child faces must be fully padded and free of any hard objects.

Forward-facing Position Warnings

Forward-facing Use Only

- If your child weighs more than 18 kg (40 lbs) or their shoulders are above the highest harness level, you **MUST** discontinue using this child restraint as it may no longer adequately protect your child.
- **DO NOT** use the lowest set of harness slots forward-facing. The harness will not properly restrain the child during a crash.
- Adjust, or remove, the **vehicle** headrest, **in the seat where the child restraint is to be installed**, so that the back of the child restraint rests against the vehicle seat back.
- The headrest on the vehicle seat in front of the child should be put in its lowest position. The vehicle seat back that the child faces must be fully padded and free of any hard objects.

⚠ WARNING

Seat Belt Warnings

Rear-facing and Forward-facing Use

- **DO NOT** use this child restraint if it moves more than 25 mm (1 inch) side to side or front to back at either the rear-facing or forward-facing belt path on the child restraint. Serious injury or death may result from poor installation. If you cannot tightly secure the child restraint, try again or move it to another location.
- **DO NOT** use this child restraint in a seating position with door-mounted seat belts.
- **DO NOT** use this child restraint in a vehicle with seat belts that automatically move along the vehicle frame when the door is opened. These seat belts will not hold a child restraint properly.
- If the vehicle seat belts are not routed and fastened correctly, the child restraint may not protect the child in a crash.
- **DO NOT** allow the vehicle seat belt release button to touch the child restraint. Accidental contact may cause the seat belt to release. If necessary, turn the seat belt release button away from the child restraint or move the child restraint to a different location.
- Failure to adjust the harness or vehicle seat belts snugly around the child may result in the child striking the vehicle's interior during a sudden stop or crash. Serious injury or death may occur.

⚠ WARNING

LATCH Warnings

Rear-facing and Forward-facing Use

- The LATCH system is intended to be used **ONLY** as described in these instructions. Serious injury or death may result from misuse. **LATCH (Lower Anchors and Tethers for CHildren)** is a system for attaching the child restraint to your vehicle seat. It can be used in place of the seat belts in vehicles with vehicle lower anchor bars. Refer to your vehicle owner's manual for the locations of the vehicle lower anchor bars. **Note:** Your vehicle owner's manual may refer to this system as "Universal Anchorage System," "Lower Universal Anchorage System," or "ISOFIX."
- In addition to these instructions, read and follow your vehicle owner's manual regarding installation of the child restraint and LATCH. If there is a discrepancy, follow your vehicle owner's manual.
- **ONLY** use for securing child restraint to vehicle lower anchor bars.
- **NEVER** attach two lower anchor connectors to one vehicle lower anchor bar.
- **NEVER** use the vehicle seat belts when using the Lower anchor connector assembly. Using both together can cause slack in a sudden stop or crash.
- To avoid strangulation, you must store the unused LATCH harness, with all slack removed, in the storage area on the back of the seat. Roll or fold the excess LATCH strap and secure with a rubber band to prevent serious injury to vehicle occupants.
- **ALWAYS** be sure that the lower anchor connectors are attached to the vehicle lower anchor bars by pulling hard on the lower anchor connectors. If they are not attached, the lower anchor connector assembly will not secure your child restraint. Serious injury or death may result.
- **DO NOT** use this child restraint if it moves more than 25 mm (1 inch) side to side or front to back at either the rear-facing or forward-facing belt path on the child restraint. Serious injury or death may result from poor installation. If you cannot tightly secure the child restraint, try again or move it to another location.

⚠ WARNING



Tether Strap Warnings

Forward-facing Use Only

- To avoid a strangulation hazard, you **MUST** tightly roll or fold excess or unused tether strap and secure with a rubber band. Attach the tether hook to the storage clip when not in use (p. 13). This will keep an unused tether from hitting someone during a crash.

Additional Warnings

Rear-facing and Forward-facing Use

- In hot or sunny weather, **ALWAYS** check the areas of the child restraint that may contact your child (e.g., buckle, buckle tongues, etc.) for hot areas before placing him/her into the child restraint. The child could be burned. Cover the child restraint with a light colored blanket when you leave the vehicle.
- This child restraint must be securely fastened to the vehicle, **even when unoccupied**, using the vehicle seat belts or lower anchor connectors. An unsecured child restraint may injure someone if a crash occurs.
- **DO NOT** use the cup holder to store cans or hard cups. Only for use with soft cups (such as styrofoam or paper).
- **DO NOT** place any cups that contain hot liquids in the cup holder.
- **DO NOT** attach additional padding, toys, or other devices not made by Evenflo or described in these instructions for the child restraint. Items not tested with the child restraint could injure the child. Additional pads or pillows may interfere with the function of the harness system, or cause breathing problems if the child's head falls forward, increasing the risk of serious injury or death.
- Failure to follow installation instructions could result in serious injury or death. These instructions and the instructions in your vehicle owner's manual must be followed carefully. If there is a conflict between the two, the vehicle owner's manual regarding child restraint installation must be followed.

⚠ WARNING

Additional Warnings— cont.

- In cold weather, **DO NOT** dress the child in bulky clothing like snowsuits if the child is riding in a child restraint. Bulky coats/snowsuits make it difficult to properly tighten the harness to the child, which may allow the child to be ejected from the restraint during a crash. If necessary, place a blanket over the harnessed child without interfering with the child restraint harness system.

Safe Practices

- **Everyone rides buckled up or the vehicle does not go.** Make no exceptions for adults or children. If someone unbuckles, stop the vehicle. Being firm and consistent from the start will mean fewer discipline problems as children get older. An unrestrained person can be thrown into and injure other passengers.
- Many safety advocates and healthcare professionals recommend that children ride rear-facing for as long as possible. See limitations recommended on rear-facing use on the inside front cover.
- **NEVER** try to tend to a crying baby's needs while driving. **NEVER** take a baby out of a child restraint for comforting while the vehicle is moving.
- **DO NOT** allow a child in a vehicle to have objects such as lollipops or ice cream on a stick. The object can injure the child if the vehicle swerves or hits a bump.
- **DO NOT** feed an infant who is riding in a child restraint.
- Put sharp or heavy items in the trunk. Anything loose can be deadly in a crash.

Recall Information for U.S. Customers

- Child restraints could be recalled for safety reasons. You must register this restraint to be reached in a recall. Send your name, address, e-mail address, the restraint's model number, and manufacturing date to:

Evenflo Company, Inc., 1801 Commerce Dr.,
Piqua, OH 45356, or call 1-800-233-5921.

You may also register on-line at:

www.evenflo.com/registercarseat

- For recall information call the U.S. Government's Vehicle Safety Hotline at 1-888-327-4236 (TTY:1-800-424-9153), or go to <http://www.NHTSA.gov>

Public Notice for Canadian Customers

- To register your child restraint, return your registration card, call 1-937-773-3971, or register on line at www.evenflo.com/registercarseatcanada
- For recall information, call Transport Canada at 1-800-333-0510 (1-613-993-9851 in Ottawa region) or Evenflo at 1-937-773-3971.

Motor Vehicle/Aircraft Usage

When used with the internal harness and properly installed pursuant to these instructions, this restraint is certified for use only in passenger and multi-purpose passenger motor vehicles, buses, and trucks equipped with Type I or II seat belts and in aircraft.

Airplane installation is the same as Type I vehicle installation. Turn the top of the airplane seat belt buckle away from the restraint for easy release and removal.

Refer to pages 44 to 48 for instructions on installing your child restraint in aircraft.



Storing Your Instructions

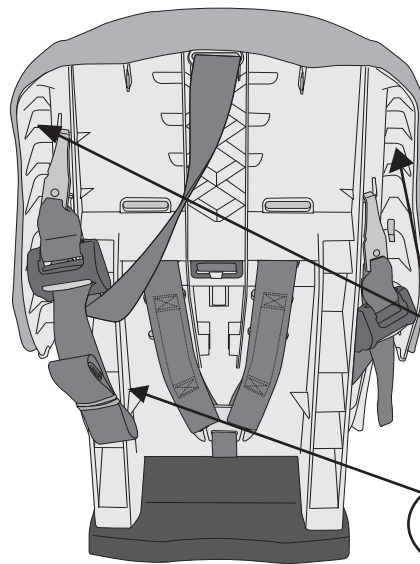

After thoroughly reading and following these instructions, **store them in the clips on either side of your child restraint.**

For future reference, record the **model number** of your child restraint AND the **date of manufacture** below.

Model Number: _____

Date of Manufacture: _____

Symbol Legend



Airbag Symbol – Alerts you to important information about airbag safety.



LATCH Symbol – Alerts you to important information about LATCH safety.



Tether Anchor Symbol – Alerts you to important information about tether anchor safety.

Visual Glossary

Your vehicle components may be significantly different than pictured. Consult your owner's manual to help you identify your vehicle components.

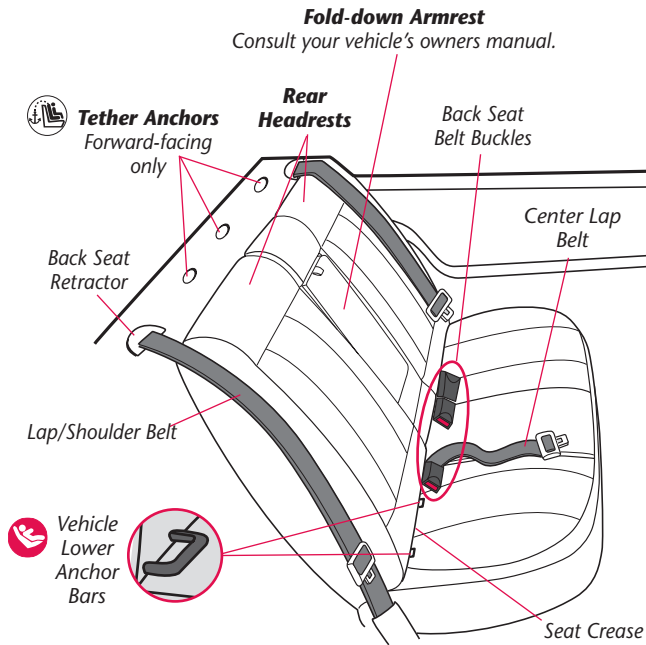

IMPORTANT: If your vehicle has **side air bags**, please refer to the warnings on page 2.

Front View

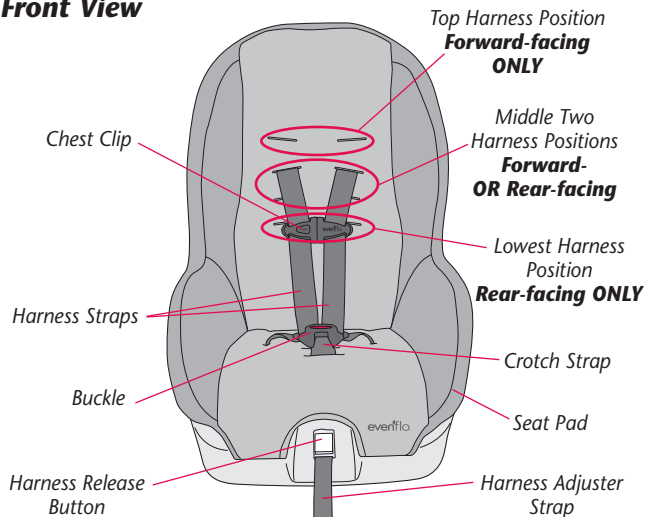

12

Visual Glossary

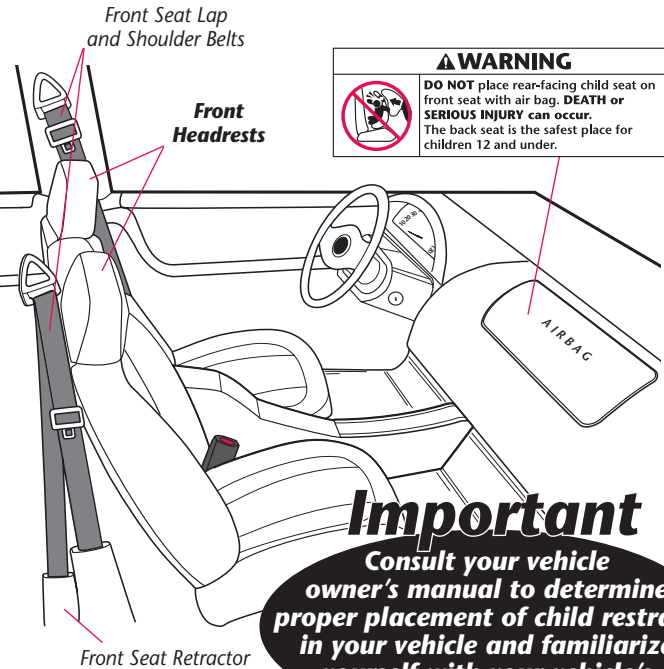

Important
Consult your vehicle owner's manual to determine proper placement of child restraint in your vehicle and familiarize yourself with your vehicle's components.

Back View

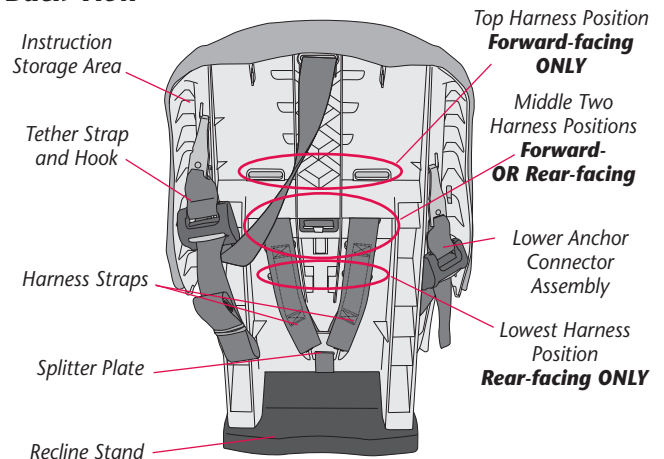

13

Securing Your Child in the Child Restraint

1

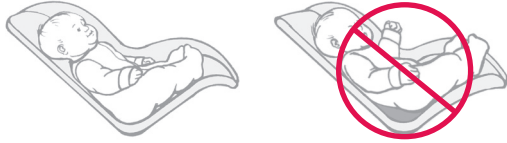

Place baby in the child restraint. The baby's back and bottom should be flat against the restraint. If there is a gap, the baby will not be comfortable.

Using the 2-piece Chest Clip

2

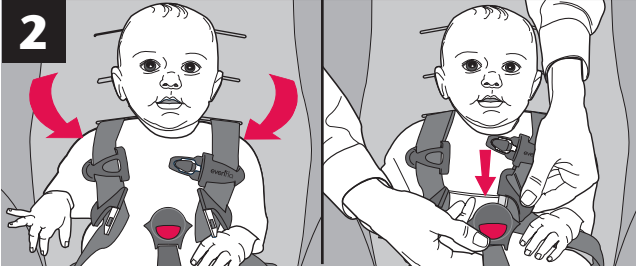

Slide each harness strap over the child's shoulders.

Insert the buckle tongues into the buckle. Pull up on the harness strap to ensure the buckle tongues are engaged.

3

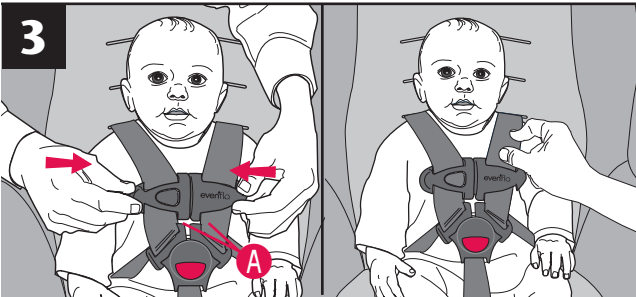

Align the two sides of the chest clip **A** and snap them together. The chest clip must be positioned at armpit level. The harness straps must be snug against the child. A snug strap should not allow any slack. It lies in a relatively straight line without sagging. It does not press on the child's flesh or push the child's body into an unnatural position. Check the harness straps near the shoulders for slack. You should **NOT** be able to pinch the harness (see illustration). Adjust as needed.

14

Removing Your Child from the Child Restraint

Using the 2-piece Chest Clip



Push the release button **A** and pull the chest clip apart.

Press the red buckle release **B**, and remove both buckle tongues **C**.

Important Information

15

Using the Tribute™ Rear-facing

Child Requirements for Rear-facing:

- **Weight:** 2.3 to 18 kg (5 to 40 lbs)
- **Height:** 48 to 94 cm (19 to 37 in.). **AND** the top of the child's head is least 25 mm (1 in.) below the top of the child restraint seat back.

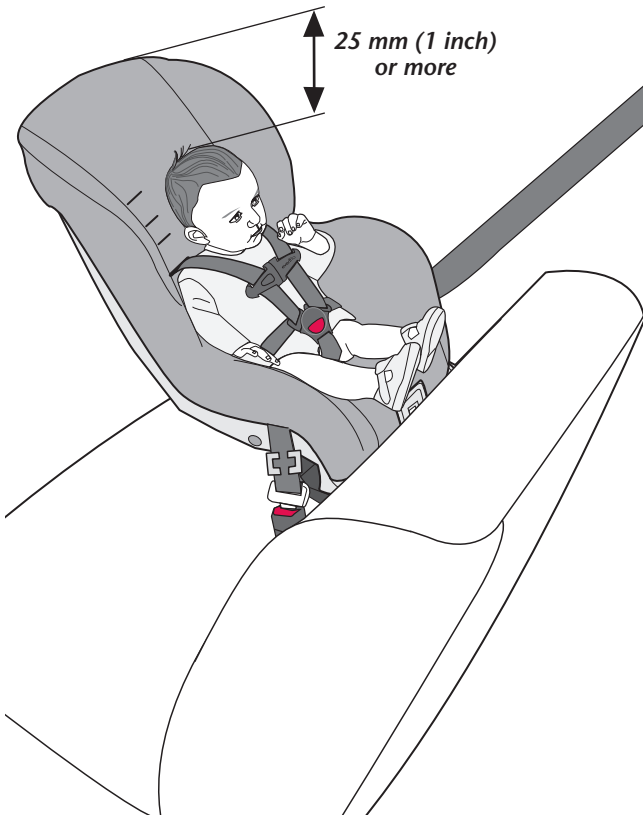

Rear-facing Installation Checklist

1. Secure child restraint to the vehicle seat.

- Recline Stand is flipped to the *Recline* position (page 18).
- Install with Lower Anchor Connector Assembly (page 19) **or** the vehicle seat belt (page 23).
- Towel rolled up and placed beneath the base, if necessary (page 18).
- Install locking clip, if necessary (page 24).

2. Set the child in the child restraint.

Top of head is at least 25 mm (1 inch) below the top of the child restraint seat back.

3. Make necessary adjustments.

- Harness straps are snug against the child's shoulders, with no slack (page 14).
- Crotch strap is snug against the child (page 39).

4. Fasten the buckle.

Refer to page 14.

5. Position and connect chest clip.

Chest clip **MUST** be at armpit level (page 14).

6. Check your work.

- Recline Stand is flipped to the *Recline* position (page 18).
- To properly secure this child restraint it **MUST NOT** move more than 25 mm (1 inch) from side to side or front to back at the rear-facing belt path (pages 22 and 25).
- The child's back and bottom are flat against the back and bottom surfaces of the child restraint.
- Shoulder harness straps **MUST** start at or below shoulder height, using the strap slots closest to your child's shoulders (page 37).
- Buckle tongues are fully engaged.
- The level arrow is level with ground (page 18).

Positioning the Recline Stand for Rear-facing Use



Lift the child restraint and flip the recline stand **A** toward the front, as shown, to the **Recline** position.

Rear-facing Recline

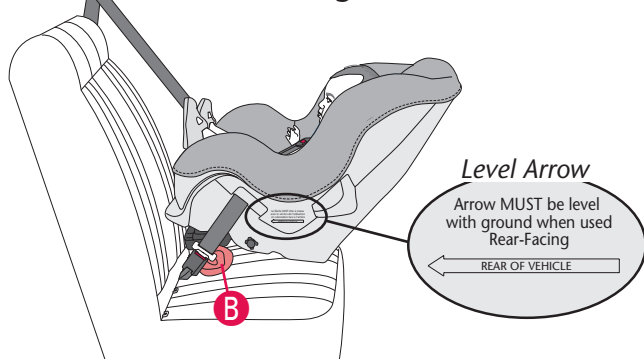

The child restraint **MUST** be in the **Recline** position for **rear-facing use**. Child **MUST** weigh 2.3 – 18 kg (5 – 40 lbs). If the level arrow is not parallel to the ground, use a tightly rolled towel or small blanket **B** beneath the front edge of the child restraint. You need to provide enough recline for an infant's head to lie back comfortably.

IMPORTANT: Infants may have difficulty breathing when in a sitting position. Make sure they recline enough for their head to lie back comfortably and safely. Failure to properly recline the child restraint could increase the child's risk of serious injury or death.

Installing the Child Restraint Rear-facing with Lower Anchor Connectors

LATCH is a system for attaching the child restraint to your vehicle seat. It is to be used in place of your vehicle's seat belts, and can be used in vehicles with **LATCH** anchors. Your vehicle owner's manual may refer to this system as **ISOFIX**, **Universal Anchorage System (UAS)**, or **Lower Universal Anchorage System**.

⚠ WARNING

- **ONLY** use for securing child restraint to lower anchor bars.
- **ALWAYS** read and follow exactly the instructions which accompany your vehicle and child restraint.
- **NEVER** attach two hooks to one vehicle lower anchor bar.
- **DO NOT** use the vehicle seat belts to install a child restraint when using the Lower Anchor Connector Assembly.
- This Lower Anchor Connector Assembly is intended to be used **ONLY** as described in these instructions. Serious injury or death may result from misuse.
- **ALWAYS** be sure that the Lower Anchor Connector hook is fully engaged onto the Vehicle Lower Anchor Bar by pulling hard on the Lower Anchor Connector strap. If it is not totally engaged, the Lower Anchor Connector Assembly will not secure your child restraint. Serious injury or death may result.
- To avoid a strangulation hazard, you **MUST** store the unused lower anchor connector assembly, with all slack removed, in storage area on the back of the seat. Roll or fold excess lower anchor connector strap and secure with a rubber band to prevent serious injury to vehicle occupants.
- In addition to these instructions, read and follow your vehicle owner's manual regarding installation of child restraints and **LATCH**. If there is a discrepancy, follow your vehicle owner's manual.

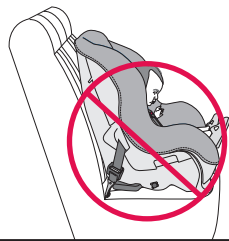

⚠ WARNING

NEVER turn a child restraint forward-facing with an infant weighing less than 10 kg (22 lbs) or less than one year of age. Crash forces may cause serious injury or death.

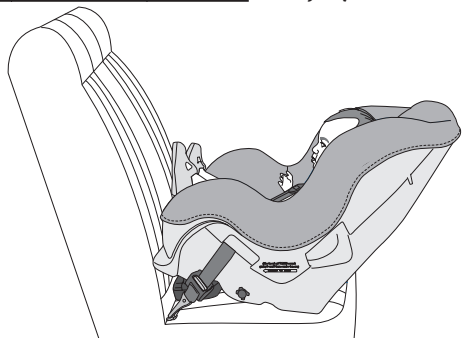

Infants **MUST** always ride facing the rear of the vehicle. The back of the child restraint supports and protects the baby and absorbs crash forces. Adjust the child restraint to the **Recline** position (p. 18). Place the child restraint in your vehicle **rear-facing**.

1

⚠ WARNING

DO NOT use the upper harness slots rear-facing. The harness may not properly restrain the child during a crash.

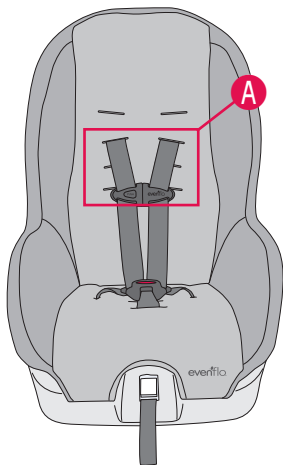

Make sure that the harness straps are in one of the three lower harness positions **A**. The harness straps must start at or below shoulder height, using the strap slots closest to your child's shoulders **B**, as shown.



2

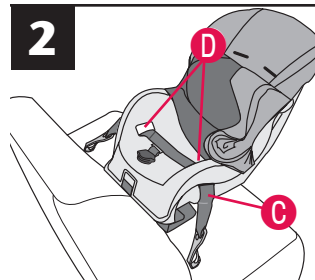

Pull the seat pad off of the front of the child restraint. Route the Lower Anchor Connector strap **C** and hook through the rear-facing belt paths **D**.

3

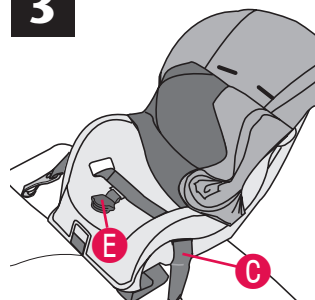

When the crotch strap **E** is in the **front** slot, route Lower Anchor Connector strap **C** **behind** the crotch strap, as shown.

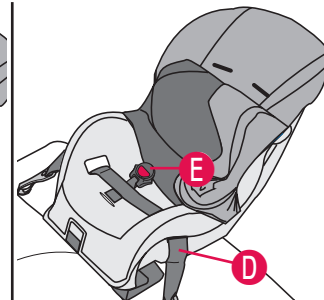

When the crotch strap **E** is in the **rear** slot, route Lower Anchor Connector strap **C** **in front of** the crotch strap, as shown.

Rear-facing

4

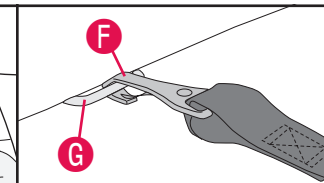
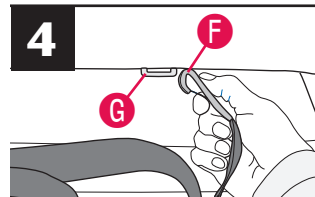

Refer to your vehicle owner's manual to locate the lower anchor bars on your vehicle seat. Attach the right hook **F** to the right anchor bar **G**, and the left hook to the left anchor bar. **DOUBLE CHECK** that the Lower Anchor Connector hook is fully engaged by pulling hard on the Lower Anchor Connector Assembly Strap.

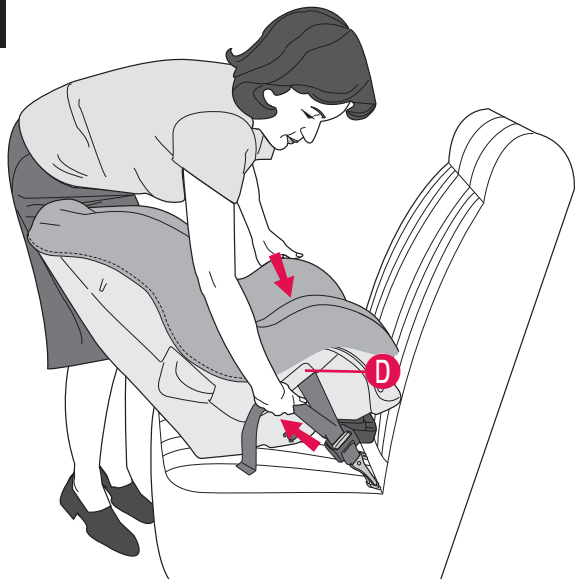
5

Using your full weight, push the child restraint firmly into the vehicle seat while pulling up on the lower anchor connector assembly strap to tighten.

The lower anchor connector assembly strap must be as tight as possible.

If you can move the child restraint more than 25 mm (1 inch) side to side or front to back at the rear-facing belt path **D**, the lower anchor connector assembly strap is not tight enough. You will need to try again, find another location for your child restraint, or install with the vehicle seat belt (page 23).

To remove the lower anchor connector assembly strap, go to page 41.

⚠ WARNING

DO NOT use this child restraint if it moves more than 25 mm (1 in.) side-to-side or front to back at the rear-facing belt path. Serious injury or death may result from poor installation. If you can not tightly secure the child restraint, try again or move it to another location, or install with the vehicle seat belt.

Installing the Child Restraint Rear-facing with a Seat Belt

⚠ WARNING

NEVER turn a child restraint forward-facing with an infant weighing less than 10 kg (22 lbs) or less than one year of age. Crash forces may cause serious injury or death.

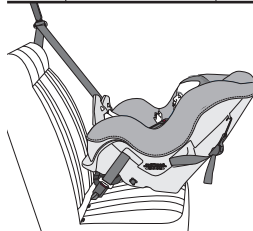
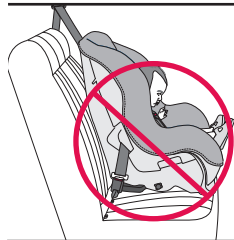

Infants **MUST** always ride facing the rear of the vehicle. The back of the child restraint supports and protects the baby and absorbs crash forces.

Adjust the child restraint to the *Recline* position (p. 18). Place the child restraint in your vehicle rear-facing.

1

⚠ WARNING

DO NOT use the upper harness slots rear-facing. The harness may not properly restrain the child during a crash.

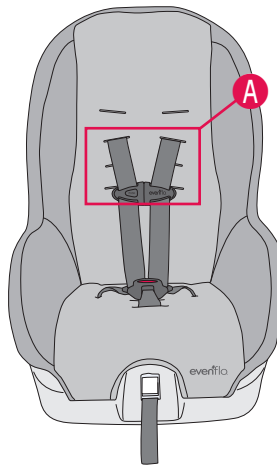

Make sure that the harness straps are in one of the three lower harness positions **A**. The harness straps must start at or below shoulder height, using the strap slots closest to your child's shoulders **B**, as shown.

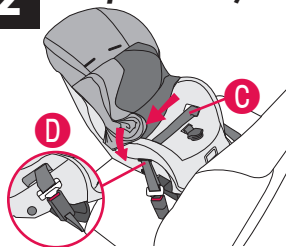

2**Lap Belt Only**

Pull the seat pad off of the front of the child restraint. Route the vehicle seat belt **C** through the rear-facing belt path **D**, continue through the opposite opening of the child restraint. Fasten the vehicle seat belt, as shown, depending on your type of seat belt.

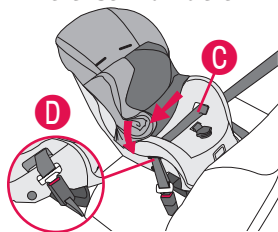
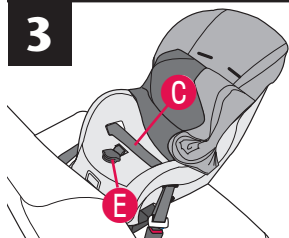
Lap & Shoulder Belt Combination**3**

When the croch strap **E** is in the **front** slot, route seat belt **C** **behind** the croch strap, as shown.

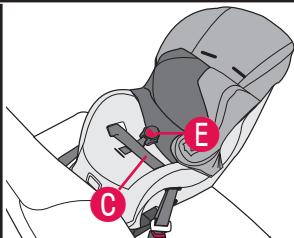

When the croch strap **E** is in the **rear** slot, route seat belt **C** **in front** of the croch strap, as shown.

4

Locking Clip installed properly.
13 mm
(0.5 inch)

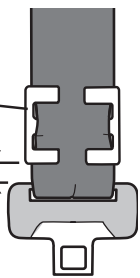
**Install Locking Clip, if necessary.**

If your vehicle was built **prior to model year 1996**, and has either a lap belt or lap/shoulder belt that is equipped with an emergency locking retractor (ELR), you **MUST** use a Locking Clip. Check your vehicle owner's manual to identify which vehicle belt system is in your vehicle.

If your vehicle is **model year 1996 or newer**, it likely has a vehicle belt system that can be locked when tightened, and will not require use of a Locking Clip.

Consult your vehicle owner's manual before installing a locking clip.

If your vehicle requires a Locking Clip, please call ParentLink (see back cover) to obtain a Locking Clip and instructions on how to install and use it.

WARNING

- Remove Locking Clip from vehicle seat belt when not used with a child restraint, or the vehicle seat belt will not properly restrain an adult or child. Serious injury could occur.

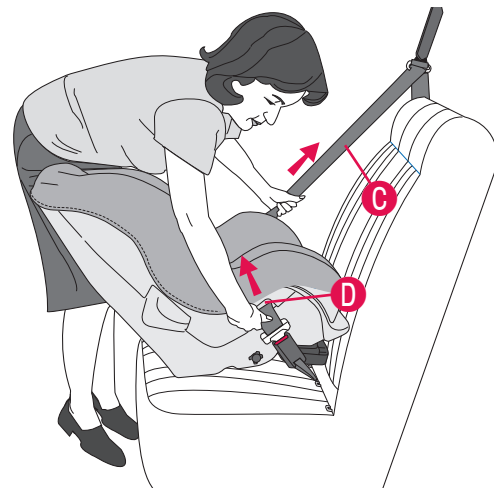
5**WARNING**

- If vehicle seat belts are not routed and fastened correctly, the child restraint may not protect your child in a crash.
 - DO NOT** use this child restraint if it moves more than 25 mm (1 in.) side to side or front to back at the rear-facing belt path. Serious injury or death may result from poor installation. If you can not tightly secure the child restraint, try again or move it to another location, or install with the lower anchor connector assembly.
- The seat belt must be as tight as possible.** Put your full weight into the child restraint as you tighten the seat belt **C**.

Check your work.

Make certain the belts are tight. If you can move the child restraint more than 25 mm (1 inch) side to side or front to back at the rear-facing belt path **D**, the vehicle belt is not tight enough. If you have not tightly secured the child restraint, try again, move it to another location, or install with the lower anchor connector assembly (p. 19).

Using the Tribute™ Forward-facing

Child Requirements for Forward-facing:

- **Weight:** 10 to 18 kg (22 to 40 lbs)
- **Height:** 71 to 102 cm (28 to 40 in.) **AND** the tops of the child's ears are below the top of the child restraint seat back.
- **Age:** At least one year of age.



IMPORTANT: Once your child exceeds 18 kg (40 lbs) **OR** is taller than 102 cm (40 in.) they can no longer safely use this child restraint and you should consider using a booster seat.

Forward-facing Installation Checklist

⚠ WARNING

If your child weighs more than 18 kg (40 lbs) or their shoulders are above the highest harness level, you **MUST** discontinue use or the child restraint will not protect your child.

1. **Secure child restraint to the vehicle seat.**

- Recline Stand is flipped to the **Upright** position (page 28).
- Install with the Lower Anchors Connector Assembly (page 29) **or** the vehicle seat belt (page 33) and tether strap (page 32/36).
- Install locking clip, if necessary (page 34).

2. **Set the child in the child restraint.**

The top of the child's ears **MUST** be below the top of the child restraint seat back.

3. **Make necessary adjustments.**

- Harness straps are snug against the child's shoulders, with no slack (page 14).
- Crotch strap is snug against the child (page 39).

4. **Fasten the buckle.** Refer to page 14.

5. **Position and connect chest clip.**

Chest clip **MUST** be at armpit level (page 14).

6. **Check your work.**

- Recline Stand is flipped to the **Upright** position (page 28).
- To properly secure this child restraint it **MUST NOT** move more than 25 mm (1 inch) from side to side or front to back at the forward-facing belt path (pages 31 and 35).
- The child's back and bottom are flat against the back and bottom surfaces of the child restraint.
- Shoulder harness straps **MUST** start at or above shoulder height, using the strap slots closest to your child's shoulders (page 37).
- Buckle tongues are fully engaged.
- Tether strap is securely attached and tightened (page 32 or 36).

Positioning the Recline Stand for Forward-facing Use



Lift the child restraint and flip the recline stand **A** toward the rear, as shown, to the *Upright* position.

Forward-facing Upright

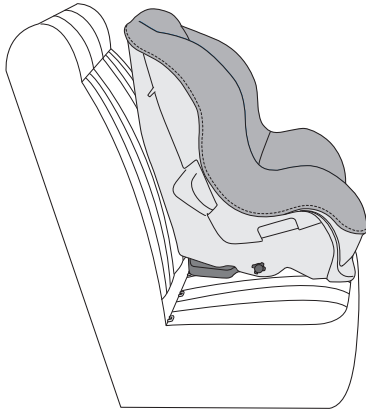

The child restraint **MUST** be in the *Upright* position for *forward-facing use*. Child **MUST** weigh 10 – 18 kg (22 – 40 lbs) and be at least one year of age.

Installing the Child Restraint Forward-facing with Lower Anchor Connector Assembly

LATCH is a system for attaching the child restraint to your vehicle seat. It is to be used in place of your vehicle's seat belts, and can be used in vehicles with *LATCH* anchors. Your vehicle owner's manual may refer to this system as *ISOFIX*, *Universal Anchorage System (UAS)*, or *Lower Universal Anchorage System*.

Note: Some vehicle manufacturers have lower maximum weight ratings for vehicle lower anchor bars, so you must consult your vehicle owner's manual or call the vehicle manufacturer to confirm the limits on your vehicle's lower anchor bars.

⚠ WARNING

- **ONLY** use for securing child restraint to vehicle lower anchor bars.
- **ALWAYS** read and follow exactly the instructions that accompany your vehicle and child restraint.
- **NEVER** attach two lower anchor connector hooks to one vehicle lower anchor bar.
- **DO NOT** use the vehicle seat belts to install a child restraint when using the lower anchor connector assembly.
- This lower anchor connector assembly is intended to be used **ONLY** as described in these instructions. Serious injury or death may result from misuse.
- **ALWAYS** be sure that the lower anchor connector hook is fully engaged onto the vehicle lower anchor bar by pulling hard on the lower anchor connector strap. If it is not totally engaged, the lower anchor connector assembly will not secure your child restraint. Serious injury or death may result.
- To avoid a strangulation hazard, you **MUST** store the unused lower anchor connector assembly, with all slack removed, in storage area on the back of the seat. Roll or fold excess lower anchor connector strap and secure with a rubber band to prevent serious injury to vehicle occupants.
- In addition to these instructions, read and follow your vehicle owner's manual regarding installation of child restraints and *LATCH*. If there is a discrepancy, follow your vehicle owner's manual.

**1**

WARNING

DO NOT use the lowest set of harness slots for **forward-facing**. The harness may not properly restrain the child in the event of a crash.

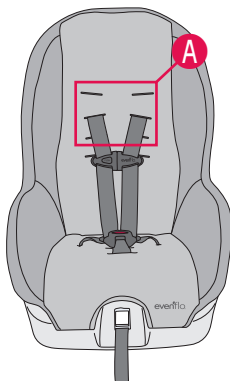

Make sure that the harness straps are in one of the top three strap slots **A**. The harness straps **MUST** be at or above shoulder height **B**, using the strap slots closest to your child's shoulders. This will provide more room for your toddler to fit comfortably.

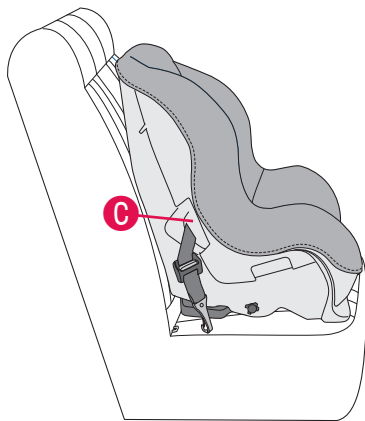
2

Place the child restraint in your vehicle **forward-facing**. Route the lower anchor connector strap and hook through the forward-facing belt path **C**.

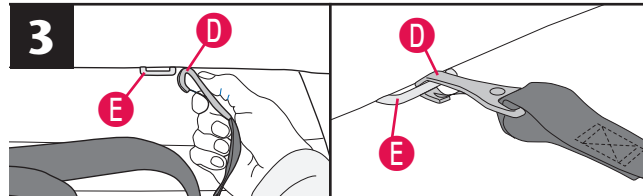
**3**

Refer to your vehicle owner's manual to locate the lower anchor bars on your vehicle seat. Attach the right hook **D** to the right anchor bar **E**, and the left hook to the left anchor bar.

DOUBLE CHECK that the lower anchor connector hook is fully engaged by pulling hard on the lower anchor connector strap.

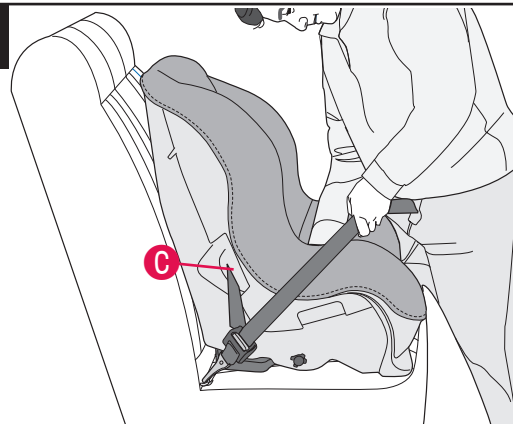
4

Using your full weight, push the child restraint firmly into the vehicle seat, while pulling up on the lower anchor connector strap to tighten.

The lower anchor connector strap must be as tight as possible. If you can move the child restraint more than 25 mm (1 in.) side to side or front to back at the belt path **C**, the lower anchor connector strap is **not tight enough**. You will need to **try again**, find another location for your child restraint, or install with the vehicle seat belt (page 33). To remove the lower anchor connector strap, go to page 41.

WARNING

DO NOT use this child restraint if it moves more than 25 mm (1 in.) side-to-side or front to back at the forward-facing belt path. Serious injury or death may result from poor installation. If you can not tightly secure the child restraint, try again, move it to another location, or install with the vehicle seat belt.

**5**

⚠ WARNING

- Failure to follow these instructions could result in serious injury to your child or other vehicle occupants.
- The tether strap is for forward-facing use **ONLY**.

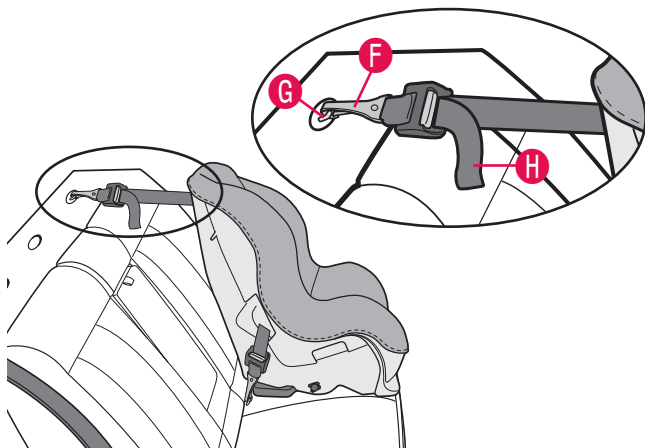

Connect the tether hook **F** to the vehicle tether anchor **G** behind the vehicle seat, as shown. (Please consult your vehicle owner's manual, as tether anchor locations may vary.) Pull the strap **H** and tighten the tether securely.

⚠ WARNING

- To avoid a strangulation hazard, you **MUST** tightly roll or fold excess tether strap and secure with the strap/rubber band.
- Attach the tether hook to the storage clip when not in use. This will keep an unused tether from hitting someone during a crash.

After adjusting the top tether strap, you may have excess strap; **DO NOT** cut it off. If you do, it may not be long enough to use in another vehicle. Instead, **tightly roll up the excess tether strap and place the rubber band around the bundle.**

Note: Refer to your **vehicle owner's manual** for the location of the tether anchor brackets in your vehicle. Older vehicles may not come equipped with anchor bracket hardware. Check with your vehicle dealer. If you have questions regarding tether anchors which are not addressed by the vehicle owner's manual, or answered by an authorized dealer/vehicle manufacturer call Evenflo's ParentLink.

Installing the Child Restraint Forward-facing with a Seat Belt

1

⚠ WARNING

DO NOT use the lowest set of harness slots for **forward-facing**. The harness may not properly restrain the child in the event of a crash.

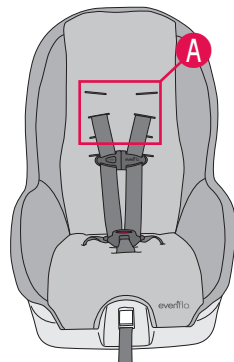

Make sure that the harness straps are in one of the top three strap slots **A**. The harness straps **MUST** be at or above shoulder height **B**, using the strap slots closest to your child's shoulders. This will provide more room for your toddler to fit comfortably.

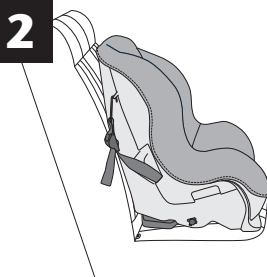
**2**

Place the child restraint in your vehicle **forward-facing**.

3

⚠ WARNING

If the vehicle belts are not routed and fastened correctly, the child restraint may not protect your child in a crash.

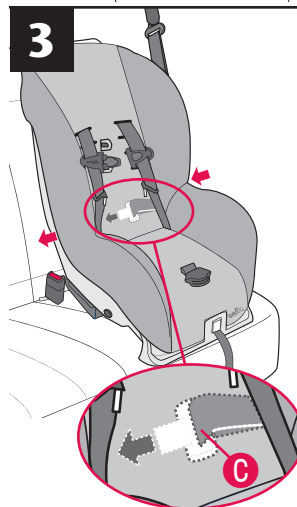

Thread the vehicle seat belt **C** through the **forward-facing** belt path behind the seat pad.

Note: Lift seat pad away from seat for easier access.

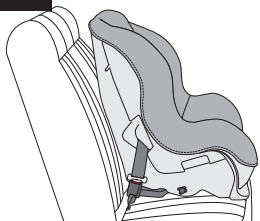
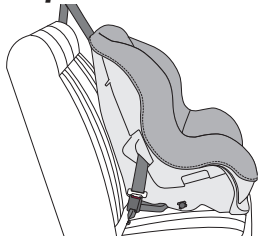
4**Lap Belt Only****Lap & Shoulder Belt**

Fasten the vehicle seat belt as shown depending on your type of seat belt.

Note: Install locking clip on lap and shoulder belt combinations, if necessary.

5**Install Locking Clip, if necessary.**

If your vehicle was built **prior to model year 1996**, and has either a lap belt or lap/shoulder belt that is equipped with an emergency locking retractor (ELR), you **MUST** use a Locking Clip. Check your vehicle owner's manual to identify which vehicle belt system is in your vehicle.

Locking Clip installed properly

13 mm
(0.5 inch)

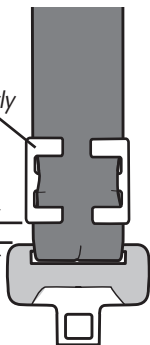

If your vehicle is **model year 1996 or newer**, it likely has a vehicle belt system that can be locked when tightened, and will not require use of a Locking Clip.

Consult your vehicle owner's manual before installing a locking clip.

If your vehicle requires a Locking Clip, please call ParentLink (see back cover) to obtain a Locking Clip and instructions on how to install and use it.

WARNING

- Remove Locking Clip from vehicle seat belt when not used with a child restraint, or the vehicle seat belt will not properly restrain an adult or child. Serious injury could occur.

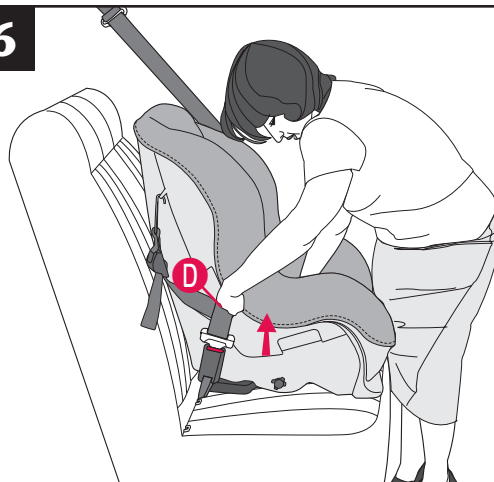
6

The vehicle seat belt must be as tight as possible.

Using your full weight, push the child restraint firmly into the vehicle seat as you tighten the vehicle belt. If you can move the child restraint more than 25 mm (1 in.) side to side or front to back at the forward-facing belt path **D**, the seat belt is **not tight enough**, you will need to **try again**, or install with the lower anchor connector assembly (page 29).

WARNING

- If vehicle seat belts are not routed and fastened correctly, the child restraint may not protect your child in a crash.
- DO NOT** use this child restraint if it moves more than 25 mm (1 in.) side to side or front to back at the forward-facing belt path **D**. Serious injury or death may result from poor installation. If you can not tightly secure the child restraint, try again or move it to another location, or install with the lower anchor connector assembly (page 29).



7

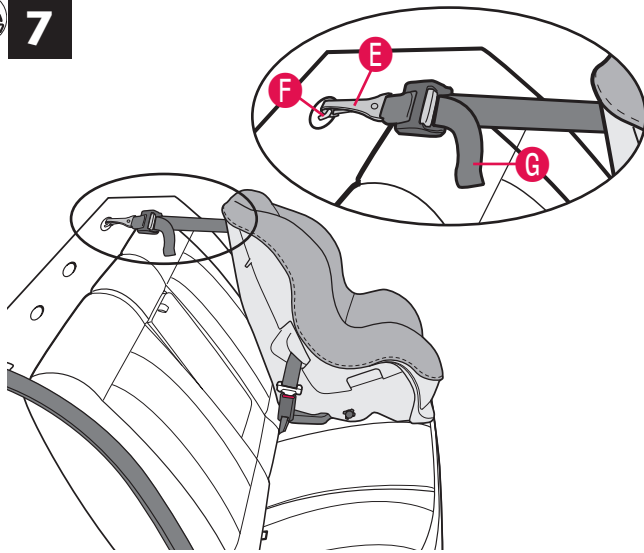

Connect the tether hook **E** to the vehicle tether anchor **F** behind the vehicle seat, as shown. (Please consult your vehicle owner's manual, as tether anchor locations may vary.) Pull the strap **G** and tighten the tether securely.

⚠ WARNING

- To avoid a strangulation hazard, you **MUST** tightly roll or fold excess tether strap and secure with the strap/rubber band.
- Attach the tether hook to the storage clip when not in use. This will keep an unused tether from hitting someone during a crash.

After adjusting the top tether strap, you may have excess strap; **DO NOT** cut it off. If you do, it may not be long enough to use in another vehicle. Instead, **tightly roll up the excess tether strap and place the rubber band around the bundle.**

Note: Refer to your **vehicle owner's manual** for the location of the tether anchor brackets in your vehicle. Older vehicles may not come equipped with anchor bracket hardware. Check with your vehicle dealer.

If you have questions regarding tether anchors which are not addressed by the vehicle owner's manual, or answered by an authorized dealer/vehicle manufacturer call Evenflo's ParentLink.

Positioning the Harness Strap

Shoulder harness straps on this child restraint are adjustable to four positions.

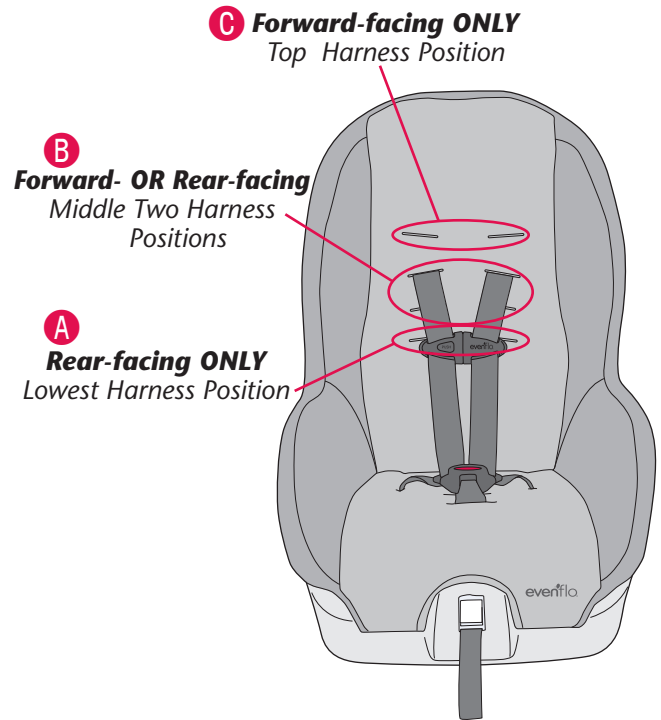

When Using in Rear-facing Position

The shoulder harness straps **MUST ALWAYS** be **at or below** the child's shoulders in one of the three lower harness positions **A** or **B** and the child's head **MUST** be at least 25 mm (1 inch) below the top of the seat back.

When Using in Forward-facing Position

The shoulder harness straps **MUST ALWAYS** be **at or above** the child's shoulders in one of the three top harness position **B** or **C**. If the top of the child's ears are above the top of the seat back, the child's shoulders fall above the highest set of harness slots, or the child weighs more than 18 kg (40 lbs) you **MUST** discontinue use of this child restraint. We recommend that you move your child to a larger child restraint or booster seat.

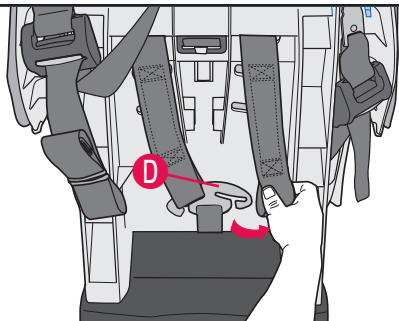
1

To change the harness strap position, loosen the shoulder harness, as shown on page 39, step 2. Slide the harness strap off of the splitter plate **D**. We suggest you do this one side at a time.

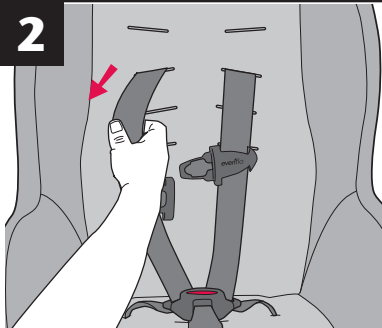
2

Pull harness strap through to the front of the child restraint. Thread each harness strap through the appropriate slot in the seat shell and the pad. Pull the harness strap to the back of the child restraint.

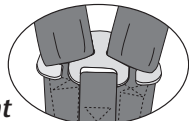
3*Infant**Toddler*

IMPORTANT: Make sure both harness straps are installed completely on the splitter plate, as shown.

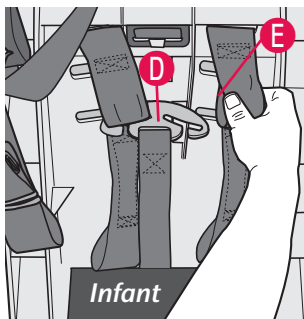
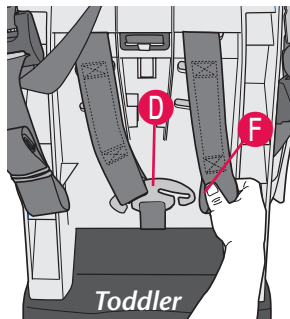
*Infant**Toddler*

There are two positions on the harness straps. The top loop **E** is for infant use. The bottom loop **F** is for use as your child grows. Reattach the harness strap onto the splitter plate **D**. Repeat on the other side.

38

Adjusting the Crotch Strap

This Child Restraint Has Two Buckle Harness Positions

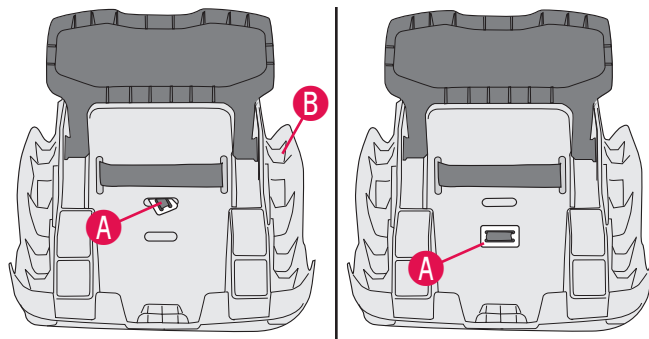

To reposition the crotch strap, first turn the child restraint upside down. Turn the crotch strap harness anchor **A** sideways and push it through the slot in the bottom of the seat shell **B**.

Reposition the harness anchor into the other slot. Make certain the harness anchor is properly seated against the seat shell **B**.

Note: The crotch strap should be snug against the child; choose the slot that is closest to the child AND the most comfortable for the child.

Adjusting the Harness Strap

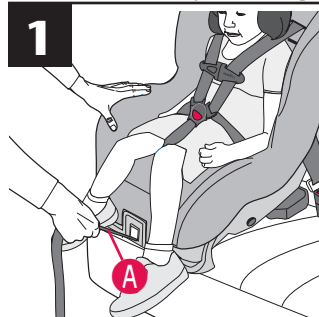
1

To tighten the harness straps, pull on the long harness adjuster strap **A** on the front of the seat.

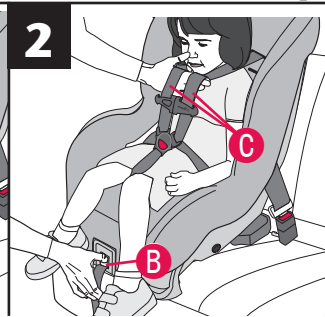
2

To loosen the harness straps, push the harness release button **B** on the front of the seat. At the same time, pull up on the harness strap **C** near the child's shoulders.

39



Removing the Tether Strap

- 1** The tether strap that comes with your child restraint will be one of the two types below.

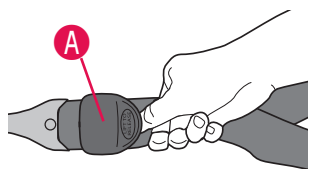

Tilt and slide the adjuster **A** to loosen.

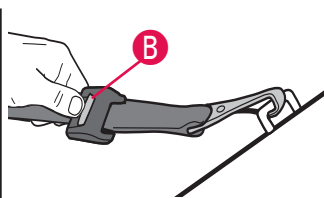

Press the adjuster release button **B** to loosen tether strap.

2

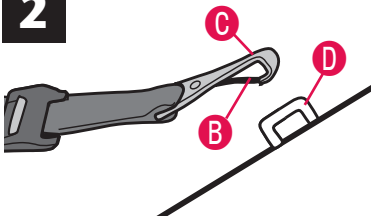

Press the tab **B** and twist, then remove the hook **C** from the anchor **D**.

3

⚠ WARNING

- To avoid a strangulation hazard, you **MUST** tightly roll or fold excess tether strap and secure with the strap/rubber band.
- Attach the tether hook to the storage clip when not in use. This will keep an unused tether from hitting someone during a crash.

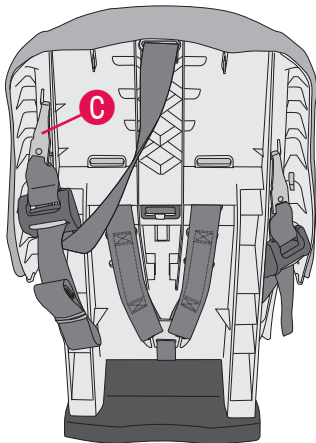

When the tether strap is not in use you **MUST** attach the hook **C** to the back of the child restraint, and tightly roll and secure the strap with the strap/rubber band. A loose tether strap and hook may injure your child.

40

Removing the Lower Anchor Connectors

- 1** The Lower Anchor Connector that comes with your child restraint will be one of the two types below.

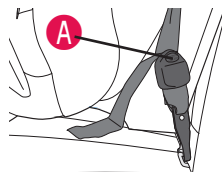

Tilt and slide the adjuster **A** to loosen.

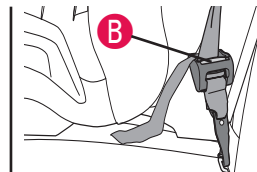

Press the adjuster release button **B** to loosen.

2

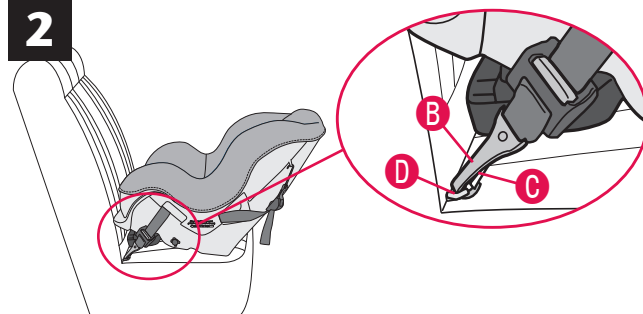

To remove the hook **B**, press the tab **C** and twist, then remove from anchor **D**.

3

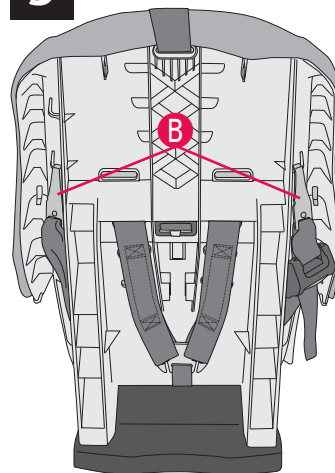

When the Lower anchor connector assembly is not in use you **MUST** attach the hooks **B** to the back of the child restraint. A loose Lower anchor connector assembly strap and hook may injure your child.

41

Installing the Accessories

Not available on all models.

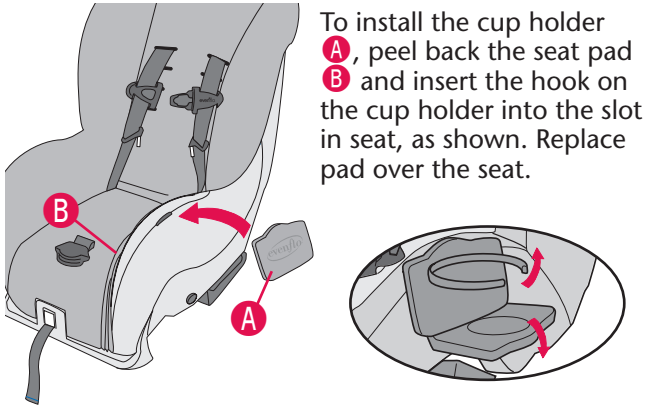

To install the cup holder **A**, peel back the seat pad **B** and insert the hook on the cup holder into the slot in seat, as shown. Replace pad over the seat.

To use the cup holder **A** fold down the lid and swing the holding arms up.

⚠ WARNING

- **DO NOT** use the cup holder to store bottles or hard containers. Only for use with soft cups (such as styrofoam or paper).
- **DO NOT** place any cups that contain hot liquids in the cup holder.
- **DO NOT** attach any other items to this child restraint unless it has been certified for use with this specific child restraint.

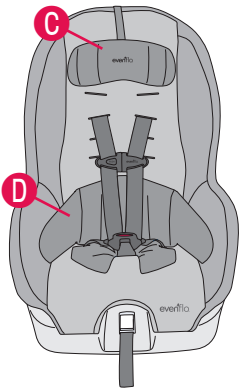

The optional Head Pillow **C** attaches easily and is used to help support the child's head.

Note: Styles may vary.

The optional Body Pillow **D** is used to help support your child by placing it in the restraint, as shown.

Care and Cleaning

- **To help protect the vehicle upholstery, place a towel beneath and behind the child restraint.**
- Plastic and metal parts may be wiped clean with mild soap and water and dried with a soft cloth. **DO NOT** use abrasive cleaners or solvents.
- Take care not to damage any labels.
- The harness can be wiped clean with mild soap and water. Allow harness to air dry. **DO NOT** immerse buckle in water or lubricate buckle.
- The seat pad can be machine washed separately in cold water, delicate cycle, tumble dry 10 – 15 minutes on low heat.
- **NEVER** use child restraint without the seat pad.
- Leather pads (not available on all models) may be cleaned. For best results spot clean with mild soap and water or with a mixture of 10 parts water to 1 part mild alcohol. Allow to air dry. **DO NOT MACHINE WASH.**

Proper Disposal of this Child Restraint

At the end of this child restraint's useful life, Evenflo encourages you to dispose of it properly. Most of the components in this child restraint are recyclable.

1. Remove all fabric and padding.
2. Remove all screws and disassemble the restraint.
3. Recycle all plastic/foam parts and discard the rest.

If your local recycling center won't accept the padding, you may dispose of it in the landfill.

Note: Evenflo uses recycled materials in the manufacturing process whenever possible but never for components that are critical for safety.

Securing Your Child Restraint in Aircraft

The Federal Aviation Administration (FAA) recommends that you secure your child for air travel in an appropriate child restraint based on your child's weight and size. Turbulence can happen with little or no warning. When turbulence occurs, **the safest place for your child is in a properly installed child restraint, not in an adult's lap or on the aircraft seat with its seat belt.** Keeping your child in a child restraint during the flight will help ensure your family arrives safely at your destination.

The FAA recommends that a child weighing:*

- more than 18 kg (40 lbs) use an aircraft seat belt;
- less than 9 kg (20 lbs) use a rear-facing child restraint; and
- from 9 to 18 kg (20 to 40 lbs) use a forward-facing child restraint.

*** Please note that these FAA recommendations may vary from those applicable to the use of your child restraint in a motor vehicle.**

IMPORTANT

You must use the internal harness when installing the child restraint in aircraft.

Installing Child Restraint Rear-facing in Aircraft

IMPORTANT: Before installing the child restraint, make sure the **aircraft seat is in a fully upright position.**

1

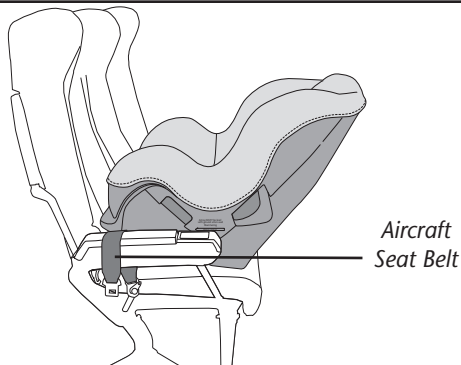

Adjust the child restraint to its **recline position** (page 18), then place it on the aircraft seat **rear-facing**, as shown above.

Installing Child Restraint Rear-facing in Aircraft

2

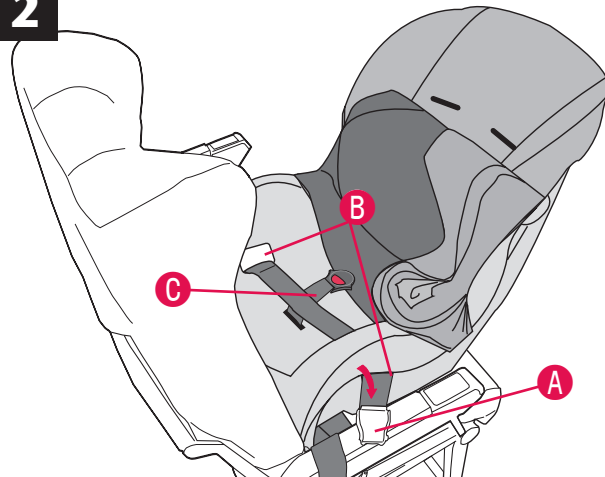

Pull the seat pad off the front of the child restraint. Route the aircraft seat belt **A** through the rear-facing belt path **B** opening on one side and continue through the belt path opening on the opposite side of the child restraint, as shown above.

3

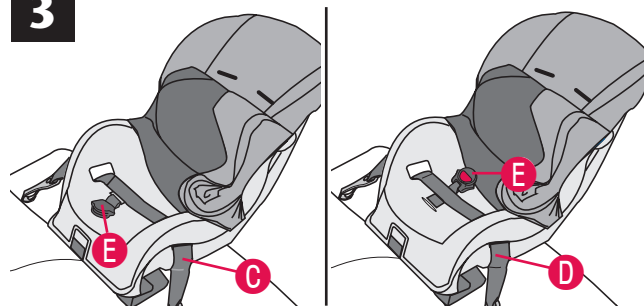

When the crotch strap **E** is in the **front** slot, route aircraft seat belt **C** **behind** the crotch strap, as shown.

When the crotch strap **E** is in the **rear** slot, route aircraft seat belt **C** **in front of** the crotch strap, as shown.

Installing Child Restraint Rear-facing in Aircraft

4

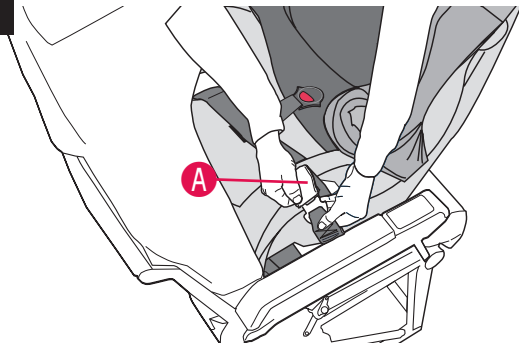

Fasten the aircraft seat belt **A**.

5

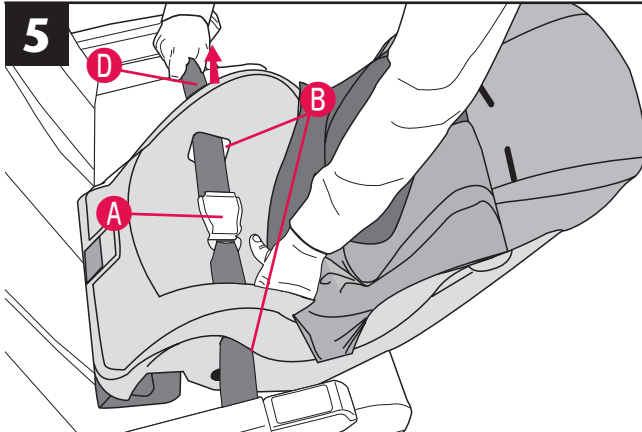

The aircraft seat belt **A** must be as tight as possible. Route the excess seat belt strap **D** back through the rear-facing belt path **B** opening, as shown above. Using your full weight, push the child restraint firmly onto the aircraft seat while pulling on the excess seat belt strap to tighten.

Check your work. Reconnect the seat pad to the front of the child restraint. Try to move the child restraint in all directions. If you can move the restraint more than 25 mm (1 inch) from side to side or front to back at the rear-facing belt path **B**, the aircraft seat belt **A** is not tight enough, and you **MUST** install again until the seat belt is tight.

Installing Child Restraint Forward-facing in Aircraft

IMPORTANT: Before installing the child restraint, make sure the **aircraft seat is in a fully upright position**.

1

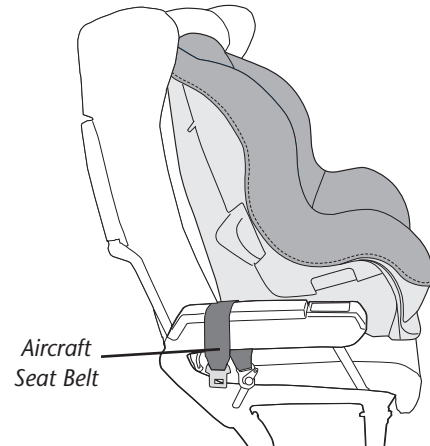

Adjust the child restraint to its **upright position** (page 28), then place it on the aircraft seat **forward-facing**, as shown above.

2

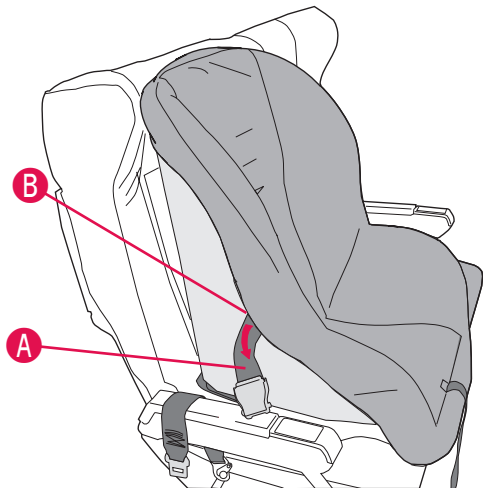

Route the aircraft seat belt **A** through the forward-facing belt path opening in the back of the child restraint and continue through the belt path opening **B** on the opposite side of the child restraint. **Note:** Lift the restraint's seat pad away for easier access.

Installing Child Restraint Forward-facing in Aircraft

3

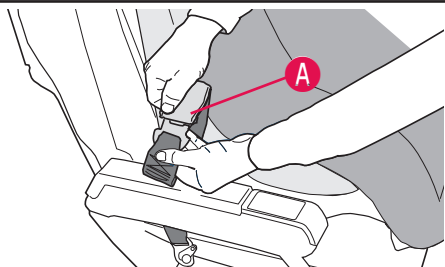

Fasten the aircraft seat belt **A**.

4

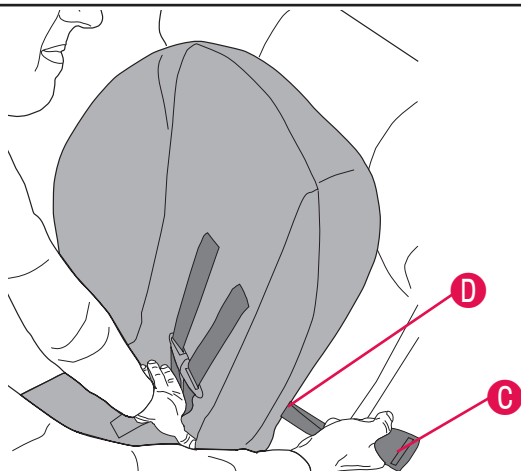

The aircraft seat belt must be as tight as possible. Route the excess aircraft seat belt strap **C** back through the forward-facing belt path **D** opening, as shown above. Using your full weight, push the child restraint firmly onto the aircraft seat while pulling on the excess seat belt strap to tighten.

Note: Because of the fixed length of aircraft seat belts, the belt buckle could be behind the child's back after tightening the belt. For your child's comfort, Evenflo recommends cushioning the child's back by placing a small pillow or folded-up blanket, or a folded-up jacket, over the belt buckle.

Check your work. Reconnect the seat pad to the front of the child restraint. Try to move the child restraint in all directions. If you can move the restraint more than 25 mm (1 inch) from side to side or front to back at the forward-facing belt path, the aircraft seat belt is not tight enough, and you **MUST** install again until the seat belt is tight.

Replacement Parts

Not available on all models. Styles may vary.

To order replacement parts you can order on-line at www.evenflo.com or contact Evenflo. When you contact us, please have the product model number and date of manufacture (found on the back of the child restraint).

1



Locking Clip:
Not included with child restraint, see page 24 or 34



2 Chest Clip



3 Retainer Strip

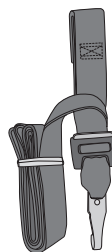

4 Tether

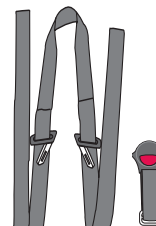

5 Harness System



6 Lower Anchor Connector Assembly



7 Cup Holder

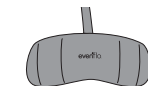

8 Head Pillow



9 Body Pillow



10 EPS Foam

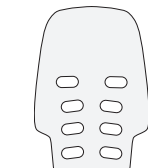

11 Head Foam

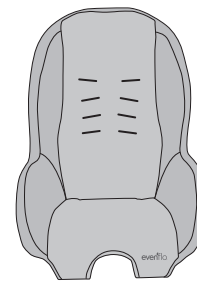

12 Seat pad & Retainer Strips

Limited Warranty

For a period of 90 days from the original purchase of this Product, Evenflo warrants to the original end user (“Purchaser”) this Product (including any accessories) against defects in material or workmanship. Evenflo’s sole obligation under this express limited warranty shall be, at Evenflo’s option, to repair or replace any Product that is determined to be defective by Evenflo and determined to be covered by this warranty.

Repair or replacement as provided under this warranty is the exclusive remedy of the Purchaser. Proof of purchase in the form of a receipted invoice or bill of sale evidencing that the Product is within the warranty period must be presented to obtain warranty service. This express limited warranty is extended by Evenflo ONLY to the original Purchaser of the Product and is not assignable or transferable to subsequent purchasers or end users of the Product. For warranty service, contact Evenflo’s ParentLink Consumer Resource Center at **www.evenflo.com**.

EXCEPT TO THE EXTENT PROHIBITED BY APPLICABLE LAW, ANY IMPLIED WARRANTY OF MERCHANTABILITY OR FITNESS FOR A PARTICULAR PURPOSE ON THIS PRODUCT IS HEREBY DISCLAIMED. EVENFLO SHALL NOT BE LIABLE FOR ANY INCIDENTAL, CONSEQUENTIAL, SPECIAL OR PUNITIVE DAMAGES OF ANY KIND FOR BREACH OF THE EXPRESS LIMITED WARRANTY ON THIS PRODUCT, OR ANY WARRANTY IMPLIED BY OPERATION OF LAW. OTHER THAN THE EXPRESS LIMITED WARRANTY SET FORTH ABOVE, THERE ARE NO OTHER WARRANTIES THAT ACCOMPANY THIS PRODUCT AND ANY ORAL, WRITTEN OR ANY OTHER EXPRESS REPRESENTATION OF ANY KIND IS HEREBY DISCLAIMED.

ParentLink®

answers. advice. affirmation.™

- **USA:** 1-800-233-5921, 8 AM to 5 PM E.T.
- **Canada:** 1-937-773-3971
- **México:** 01-800-706-12-00



INSTRUCTIONS

ParentLink®

answers. advice. affirmation.™

- **USA:** 1-800-233-5921, 8 AM to 5 PM E.T.
- **Canada:** 1-937-773-3971
- **México:** 01-800-706-12-00