

evenflo®

LiteMax™ 35 Rear-facing Child Restraint System

Owner's Manual
Keep for future use

Rear-facing*
1.8 to 15.8 kg
(4 to 35 lbs)

43 to 81 cm
(17 to 32 in.)

* See page 1
for complete
requirements.



Para instrucciones en Español,
llamar al: 1-800-233-5921

⚠ WARNING:

To reduce the risk of serious injury
or death, read this owner's manual prior
to installing and using this child restraint.

More children are killed every year as passengers in car crashes than by any other type of injury. To reduce the risk of **SERIOUS INJURY** or **DEATH**, read this owner's manual and your vehicle owner's manual before installing and using this child restraint. Using a child restraint makes a big difference. By properly using this child restraint and following these instructions (and the instructions that accompany your vehicle), you will greatly reduce the risk of serious injury or death to your child from a crash. Do not be misled by the commonly used term "safety seat"; no restraint system can prevent all injuries in all crashes. Many properly restrained adults and children are injured in motor vehicle crashes, including relatively minor crashes. A properly used child restraint is the best way to minimize injuries to your child and to increase the chances for your child's survival in most crashes.

Table of Contents

Premature Infant Use	2
Warnings	3
LATCH Warnings.....	7
Safe Practices	9
Recall Information for U.S. Customers	9
Public Notice for Canadian Customers	10
Motor Vehicle/Aircraft Usage	10
Care and Cleaning.....	10
Storing Your Instructions	11
Visual Glossary	12
Using the Handle	16
Proper Installation WITH the Convenience Base	
Installation Checklist.....	19
Installing the Convenience Base with the Lower Anchor Connector Assembly	20
Installing the Convenience Base with the Vehicle Seat Belt	28
Placing the Carrier in the Base	34
Releasing the Carrier from the Base	35
Proper Installation WITHOUT the Convenience Base	
Installation Checklist	37
Installing the Carrier without the Convenience Base	38
Securing the Child in the Carrier.....	41
Removing the Child from the Carrier	43
Changing the Harness Position	44
Changing the Crotch Strap Position	46
Changing the Waist Strap Position	48
Removing the Lower Anchor Connector Assembly.....	52
Using as an Infant Carrier	54
Securing Your Child Restraint in Aircraft	56
Installing Carrier without Convenience Base in Aircraft.....	57
Installing the Canopy.....	60
Installing the Accessories	60
Removing the Seat Pad	62
Replacement Parts	64
Limited Warranty	66

U.S. REGULATORY NOTICE

This child restraint meets all the requirements of Federal Motor Vehicle Safety Standard 213.

For Canadian Models

CANADIAN REGULATORY NOTICE (MODEL NUMBERS ENDING IN "C")

This child restraint meets all the applicable requirements of Canadian Motor Vehicle Safety Standard 213.1.

Child Requirements

- *No restraint can guarantee absolute protection from injury in every crash.*
- *This child restraint is designed for use **ONLY** by children in rear-facing position. To use this child restraint properly, children **MUST** meet weight/size specifications as follows:*

For Rear-facing Use ONLY

- 1.8 – 15.8 kg (4 – 35 lbs)
- 43 – 81 cm (17 – 32 inches)
- Top of head is at least 25 mm (1 inch) below the top of the child restraint seat back.

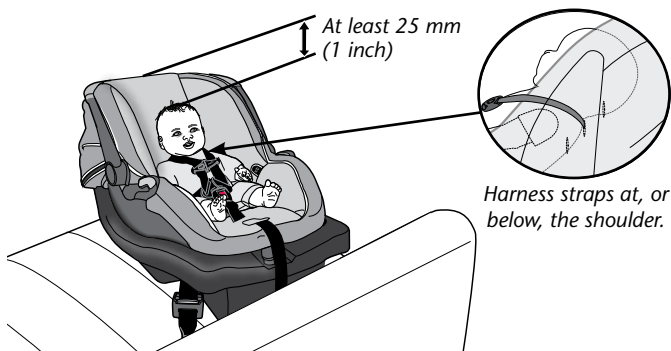

Symbol Legend



Airbag Symbol – Alerts you to important information about airbag safety.



LATCH Symbol – Alerts you to important information about LATCH safety.



Tether Anchor Symbol – Alerts you to important information about tether anchor safety.



Aircraft Symbol – Alerts you to important information about aircraft safety.

WARNING

Premature Infants

- **DO NOT** use this or any other child restraint with a premature infant until after consulting your doctor. Premature infants may have difficulty breathing when in a sitting position.

PREMATURE INFANT USE

Before using this child restraint for preterm or low birth weight infants, you must read and follow the guidelines in this section.

According to the U.S. National Highway Traffic Safety Administration, a properly installed child restraint reduces the risk of death by over 70% for infants involved in crashes. Federal Motor Vehicle Safety Standard (FMVSS) 213 establishes design and dynamic performance requirements for child restraint systems. However, the standard has no minimum weight limit and does not address the special medical needs of preterm or low birth weight infants. To ensure that preterm and low birth weight infants are transported safely, the guidelines published by the American Academy of Pediatrics (AAP) in Pediatrics 2009;123:1424–1429 must be followed.

All children should ride rear-facing in the vehicle as long as possible. Preterm and low birth weight infants are at additional risk of breathing difficulties and heart problems when placed in a child restraint. Evenflo requires that the evaluation recommended by the AAP be conducted for all infants born earlier than 37 weeks and all newborn infants who weigh less than 5 lb at birth before their first car trip to check for breathing difficulties or heart rate problems when traveling in a rear-facing child restraint.

The AAP recommends that appropriate hospital staff observe your infant in the child restraint for a period of 90 to 120 minutes or the duration of travel, whichever is longer. This period of observation must be performed with the infant properly positioned as described in these instructions and with the child restraint placed at an angle that is approved for use in the vehicle. The hospital staff will check for any breathing difficulties or heart rate problems. Your child's pediatrician will let you know if there are any special considerations for travel. The number of trips and the duration of time the infant is seated in the child restraint should be minimized. A caregiver should ride in the back seat to monitor the infant during travel.

PREMATURE INFANT USE - *continued*

You can learn more about the AAP's recommendations for observation of newborns and the guidelines for safe transportation of preterm and low birth weight infants, as well as other resources for parents and medical professionals, at <https://www.healthychildren.org/english/safety-prevention/on-the-go/Pages/default.aspx>

⚠️WARNING

General Warnings

- Child restraints should be used only for travel. Potential adverse health effects from excessive use of infant child restraints have been documented. You should limit the time spent each day in a child restraint as much as possible. You must **NEVER** use your child restraint as a sleeping environment in the home. **NEVER** leave your infant unattended in a child restraint in or out of the vehicle.
- Failure to follow installation instructions can result in your child striking the vehicle's interior during a sudden stop or crash. Serious injury or death may result. These instructions and the instructions in your vehicle owner's manual must be followed carefully. If there is a conflict between the two, the vehicle owner's manual regarding child restraint installation must be followed.
- This child restraint **MUST ALWAYS** face the **rear of the vehicle**. Serious injury or death can occur if used forward-facing.
- **NEVER** leave child unattended.
- **DO NOT** use child restraint if it is damaged, broken, or missing parts.
- **DO NOT** use this restraint if it has been involved in a crash. It must be replaced.
- **DO NOT** attach additional padding, toys or other devices not made by Evenflo, or described in these instructions, to the child restraint. Items not tested with the child restraint could injure the child.
- Be sure that the handle is firmly locked in **Position 1** (Carry) before lifting the child restraint (see pages 16-17).
- This child restraint must be securely belted to the vehicle at all times, even when unoccupied. An unsecured child restraint may injure someone if a crash occurs.

⚠ WARNING

Air Bag Warnings

- **DO NOT** use this restraint in the front seat of a vehicle equipped with an air bag. Interaction between a rear-facing restraint and air bags may cause serious injury or death. If your vehicle has an air bag, refer to the vehicle owner's manual for child restraint installation.
- If the rear seat of your vehicle is equipped with side air bags, refer to the following information for proper usage.
Vehicles built prior to the 2002 model year:
DO NOT use this restraint in a vehicle seating position equipped with a side air bag unless authorized by the vehicle manufacturer.
Model year 2002 and newer vehicles:
Refer to your vehicle owner's manual before placing this restraint in a seating position equipped with a side air bag.
- **DO NOT** place any objects between the restraint and the side air bag, as an expanding air bag may cause the items to strike your child.

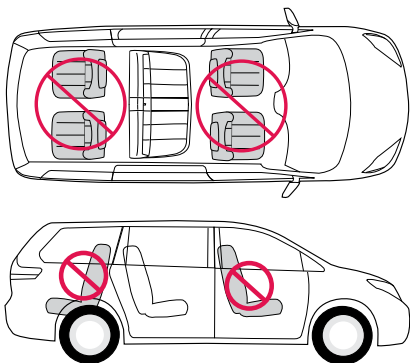

⚠WARNING

Location Warnings

- **ALWAYS** read and follow exactly the instructions that accompany your vehicle and child restraint.
- According to accident statistics, children are safer when properly restrained in a rear seating position than in a front seating position. Generally, the center rear is safest and should be used if available. Children 12 and under should ride in the back seat of the vehicle.
- If you are unable to use the center rear seating position and have to install this child restraint directly behind a front vehicle seat, ensure that there is at least 38 mm (1.5 inches) of space between any part of the child restraint and the vehicle seat that is closest to the child's head. This space may be necessary for the child restraint to properly perform in certain types of crashes.
- **ONLY** use this child restraint on forward-facing vehicle seats. **DO NOT** use on vehicle seats which face the rear or side.
- **ONLY** use this child restraint on vehicle seats with backs that lock into place.
- Some child restraints do not fit all vehicles or all seating locations. There are thousands of combinations of vehicle makes, models, child restraint configurations, seat belt designs and seat cushion shapes. The easiest way to determine whether your child restraint is suitable for a particular seating position is to check for a tight installation. If the child restraint cannot be properly installed, **DO NOT** use this child restraint. Consult vehicle owner's manual, try a different seating location or call Evenflo at 1-800-233-5921 (U.S), or 1-937-773-3971 (Canada).

WARNING

Vehicle Seat Belt Warnings

- **DO NOT** use this child restraint in a vehicle seating position with door-mounted seat belts.
- **DO NOT** use this child restraint in a vehicle seating position with seat belts that automatically move along the vehicle frame when the door is opened. These seat belts will not hold a child restraint properly.
- **DO NOT** loosen the vehicle seat belt to provide more leg room as this will prevent the child restraint from protecting your child.
- Fold-down armrests could pose a hazard to a rear-facing child in certain types of collisions. Consult your vehicle owner's manual before installing any rear-facing child restraint in front of a fold-down armrest.
- The headrest on the vehicle seat that the child faces should be placed in the lowest position. The vehicle seat back that the child faces must be fully padded and free of any hard objects.
- **DO NOT** use this child restraint if it moves more than 25 mm (1 inch) side-to-side or front to back at the seat belt path. Serious injury or death may occur. Try again or move the child restraint to another seating location.
- If the vehicle seat belts are not routed and fastened correctly, the child restraint may not protect your child in a crash.
- **DO NOT** allow the vehicle seat belt release button to touch the child restraint. Accidental contact may cause the seat belt to release. If necessary, turn the vehicle seat belt release button away from the child restraint or move the child restraint to a different location.
- Failure to adjust the harness snugly around your child may result in your child striking the vehicle's interior during a sudden stop or crash. Serious injury or death may occur.

!WARNING



LATCH Warnings

- The LATCH (**L**ower **A**nchors and **T**ethers for **C**hildren) system is intended to be used **ONLY** as described in these instructions. Serious injury or death may result from misuse. LATCH is a system for attaching the child restraint to your vehicle seat. It can be used in place of the seat belts in vehicles with vehicle lower anchor bars. Refer to your vehicle owner's manual for the locations of the vehicle lower anchor bars. **Note:** Your vehicle owner's manual may refer to this system as "Universal Anchorage System," "Lower Universal Anchorage System," or "ISOFIX."
- In addition to these instructions, read and follow your vehicle owner's manual regarding installation of the child restraint and LATCH. If there is a discrepancy, follow your vehicle owner's manual.
- **ONLY** use for securing convenience base to vehicle lower anchor bars.
- **NEVER** attach two lower anchor assembly connectors to one vehicle lower anchor bar.
- **NEVER** use the vehicle seat belts when using the lower anchor connector assembly. Using both together can cause slack in a sudden stop or crash.
- When not in use, the lower anchor connector assembly should be securely stored in the storage area located under the convenience base. Keep out of reach of children.
- **ALWAYS** be sure that the lower anchor connectors are fully engaged onto the vehicle anchor bars by pulling hard on the lower anchor connector assembly harness. If they are not totally engaged, the lower anchor connector assembly will not secure your child restraint. Serious injury or death may result.
- **DO NOT** use this child restraint if it moves more than 25 mm (1 inch) side-to-side or front to back at the vehicle belt path. Serious injury or death may result from poor installation. If you can not tightly secure the child restraint, try again or move it to another location.

⚠ WARNING

Usage Warnings

- Children have **STRANGLED** in loose or partially buckled harness straps. Fully restrain the child even when carrier is used outside the vehicle.

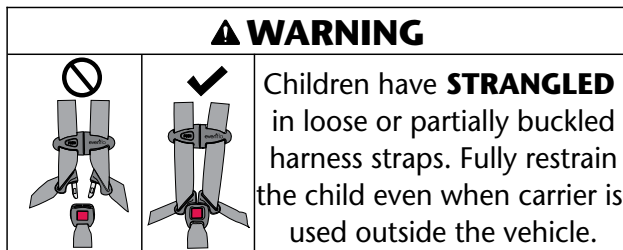

- Use **ONLY** the LiteMax 35 convenience base with the LiteMax 35 carrier. The LiteMax 35 carrier **WILL NOT LOCK** safely into any other convenience base and serious injury or death may result. Refer to pages 12 and 13 to properly identify the LiteMax 35 convenience base.
- **ALWAYS** check the restraint and buckle for hot surfaces before putting a child into the restraint. Your child could be burned.
- In cold weather, **DO NOT** dress the child in bulky clothing, like snowsuits, if the child is riding in a child restraint. This clothing makes it difficult to properly tighten the harness to the child, which may allow the child to be ejected from the restraint during a crash.
- **ALWAYS** place the handle in **Position 3** (U.S. models) or **Position 1** (Canadian models) when using this child restraint in a vehicle (p. 16).
- When using this restraint in **Position 4** (Stand) (p. 16), **ONLY** use on level ground and **NEVER** prop the restraint up with any object.
- **NEVER** place this child restraint on beds, sofas, or other soft surfaces. The child restraint can roll over on soft surfaces and suffocate the child.
- **NEVER** place this child restraint near the edges of counter tops, tables, other high surfaces, or in shopping carts. The child's movements can cause the child restraint to slide and fall.
- The canopy is not intended to provide UV protection.

Safe Practices

- **Everyone rides buckled up or the vehicle does not go.** Make no exceptions for adults or children. If someone unbuckles, stop the vehicle. Being firm and consistent right from the start will mean fewer discipline problems as children get older. Besides, an unrestrained child or adult can be thrown into and injure other passengers.
- **NEVER** try to tend to a crying baby's needs while driving. **NEVER** take a baby out of a child restraint for comforting while the vehicle is moving.
- Always place the handle in **Position 3, or 4** before removing infant from carrier (p. 16).
- **DO NOT** allow a child to have objects such as lollipops or ice cream on a stick. The object can injure the child if the vehicle swerves or hits a bump.
- **DO NOT** feed an infant who is riding in a child restraint.
- Anything loose can be deadly in a crash. Put sharp or heavy items in the trunk.
- **DO NOT** dress the child in blanket sleepers or other clothing that would prevent the crotch strap from fitting snugly up against the child.

Recall Information for U.S. Customers

- Child restraints could be recalled for safety reasons. You must register this restraint to be reached in a recall. Complete the registration card provided and mail it to Evenflo or send your name, address, e-mail address, the restraint's model number, and manufacturing date to:

Evenflo Company, Inc.
1801 Commerce Dr.
Piqua, OH 45356
or call **1-800-233-5921**.

You may also register on-line at

www.evenflo.com/registercarseat

- For recall information call the U.S. Government's Vehicle Safety Hotline at 1-888-327-4236 (TTY:1-800-424-9153), or go to: **<http://www.NHTSA.gov>**

Public Notice for Canadian Customers

- Child restraints could be recalled for safety reasons. You must register this restraint to be reached in a public notice. Complete the registration card provided and mail it to Evenflo or send your name, address, e-mail address, the restraint's model number, and manufacturing date to:
Evenflo Company, Inc.
1801 Commerce Dr.
Piqua, OH 45356
or call **1-937-773-3971** or register on-line at **www.evenflo.com/registercarseatcanada**
- For public notice information, call Transport Canada at 1-800-333-0510 or go to **www.tc.gc.ca**

Motor Vehicle/Aircraft Usage

When used with the internal harness and properly installed pursuant to these instructions,

this restraint is certified for use only in passenger and multi-purpose passenger motor vehicles, buses, and trucks equipped with either lap belts only or lap/shoulder belt systems, and in aircraft.

Refer to pages 56 to 59 for complete instructions on installing your child restraint in aircraft.



Care and Cleaning

- To clean pad, slide the elastic loops/plastic clips of the seat pad off of the seat shell (p. 62). Remove the harness system. See "Changing the Harness Position" on page 40 to ensure proper reinstallation of harness straps.
- Machine wash cloth pad, body pillow and head support (available on some models) separately in cold water, delicate cycle, and tumble dry 10 – 15 minutes, low heat.
- Wipe straps, buckles, canopy, and harness adjuster with warm damp cloth and mild soap. Air dry.
- To help protect the vehicle upholstery, place a towel beneath and behind the child restraint.

Storing Your Instructions

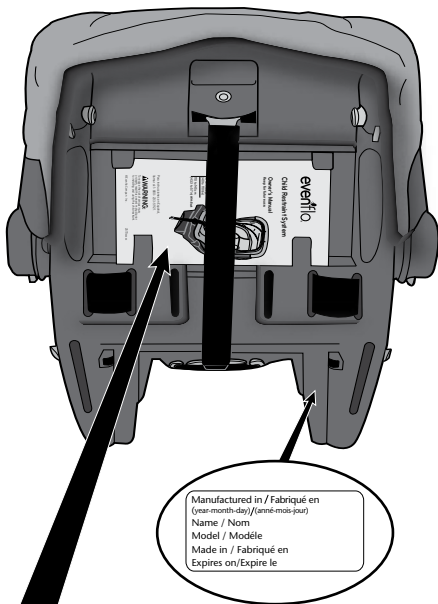

After thoroughly reading and following these instructions, store them in the slots on the bottom of the child restraint.

*For future reference, record the **model number** of your child restraint AND the **date of manufacture** below.*

Model Number: _____

Date of Manufacture: _____

Visual Glossary

Your vehicle components may be significantly different than pictured. Consult your vehicle owner's manual to help you identify your vehicle components.

Back Seat

Fold-down Armrest

Consult your vehicle owner's manual.

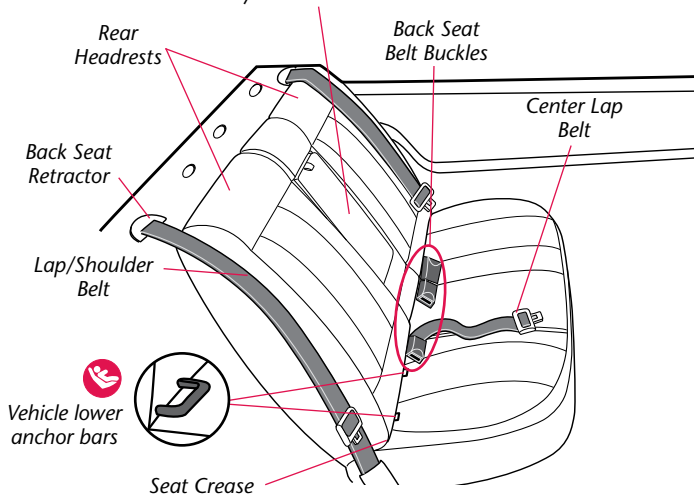

LiteMax Convenience Base with One Step Lock-Off

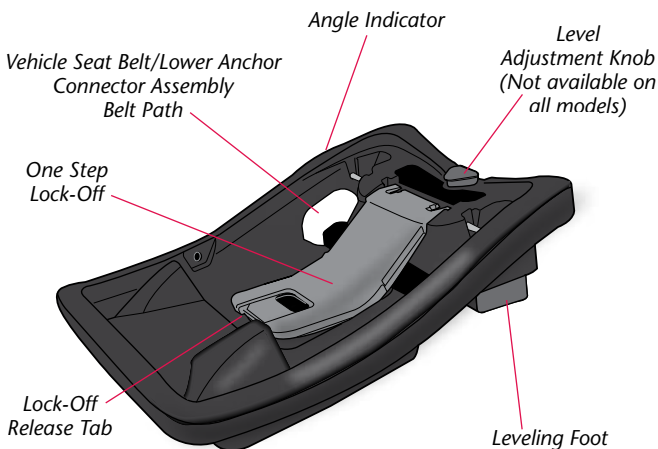

Front Seat

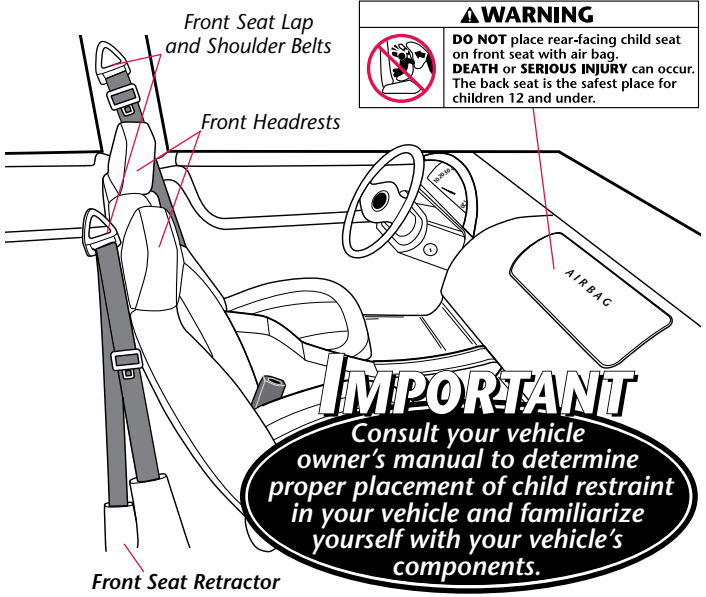

LiteMax Convenience Base with Two Step Lock-Off

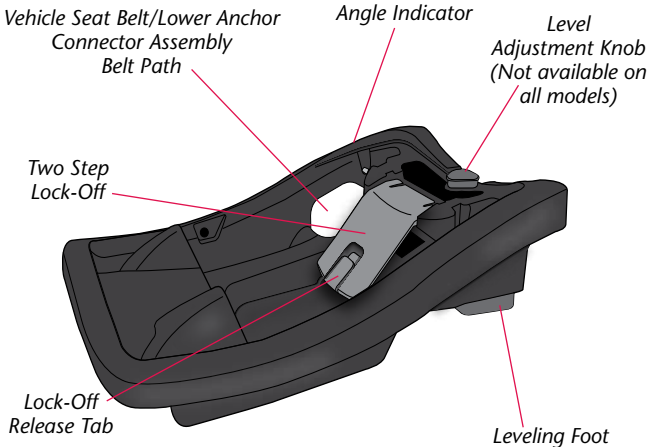

Child Seat Features

Front

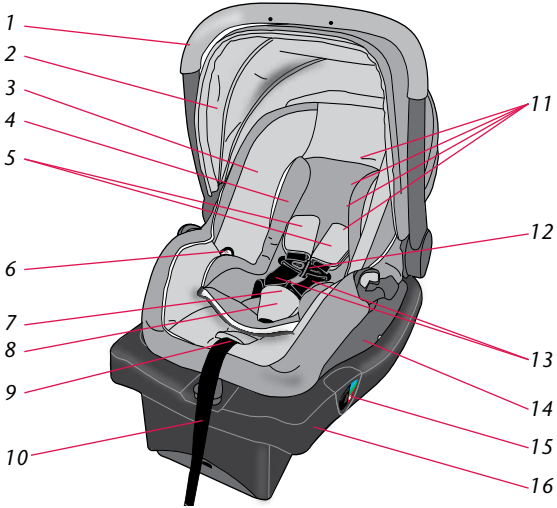

Back

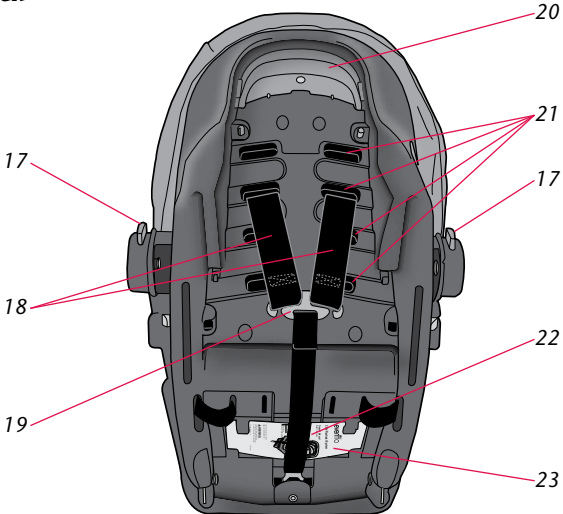

Child Seat Features

Description

- 1.** Handle
- 2.** Canopy
- 3.** Seat Pad
- 4.** Body Pillow*
- 5.** Harness Covers*
- 6.** Buckle Tongue Storage*
- 7.** Crotch Buckle
- 8.** Crotch Buckle Cover*
- 9.** Harness Release Button
- 10.** Harness Adjuster Strap
- 11.** Harness Slots
- 12.** Chest Clip
- 13.** Harness Straps
- 14.** Carrier
- 15.** Level Indicator
- 16.** Convenience Base
- 17.** Handle Release
- 18.** Harness Straps
- 19.** Splitter Plate
- 20.** Carrier Release Handle
- 21.** Harness Slots
- 22.** Crotch Strap Anchor (under instructions)
- 23.** Instructions

* Not all features are available on all models. Styles may vary.

Using the LiteMax Handle

To change handle positions, squeeze **both** Handle Releases and rotate the handle to the desired position until it locks into place.

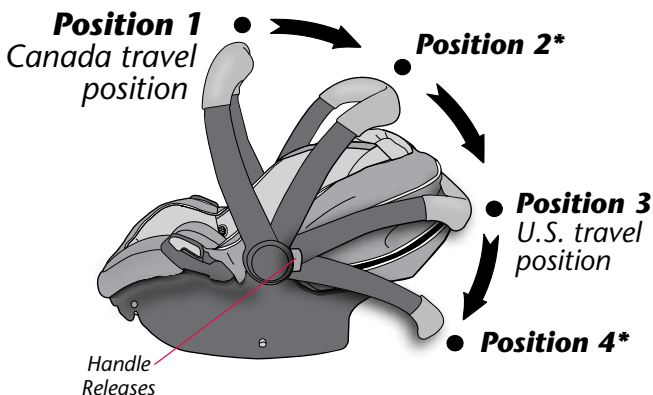

***IMPORTANT: NEVER** use **Positions 2** or **4** when traveling in a vehicle.

Position 1 – This position is to be used to carry your child. For Canadian models, you **MUST** place the handle in this position when traveling in a vehicle.

Position 2 – **NEVER** use this position to carry your child in the carrier. **NEVER** use this position in the vehicle.

Position 3 – For U.S. models, you **MUST** place the handle in this position while traveling in a vehicle.

Position 4 – Place the handle in this position when you set the carrier on the floor. **NEVER** use this position in a vehicle.

Using the LiteMax Handle

IMPORTANT: Always secure the child in the carrier. Refer to "Securing your Child in the Carrier" on page 41.

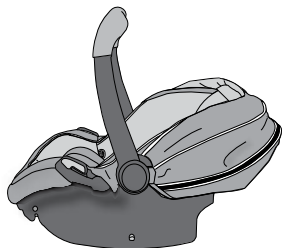

Position 1 (Carry and Travel – Canada)

This position is to be used to carry your child. For Canadian models, you **MUST** place the handle in this position when traveling in a vehicle.

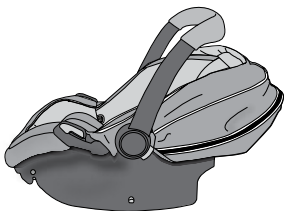

Position 2 (Convenience)

NEVER use this position to carry your child in the carrier. **NEVER** use this position in the vehicle.

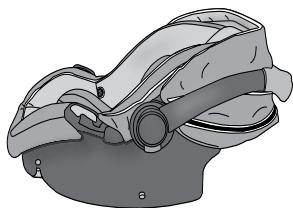

Position 3 (Travel – U.S.)

For U.S. models, you **MUST** place the handle in this position while traveling in a vehicle.

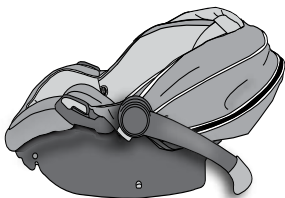

Position 4 (Stand)

Place the handle in this position when you set the carrier on the floor. **NEVER** use this position in a vehicle.

Proper Installation WITH the Convenience Base

Child Requirements

Weight: 1.8 – 15.8 kg (4 – 35 lbs)

Height: 43 – 81 cm (17 – 32 inches)

Top of head must be at least 25 mm (1 inch)
below the top of the child restraint seat back.

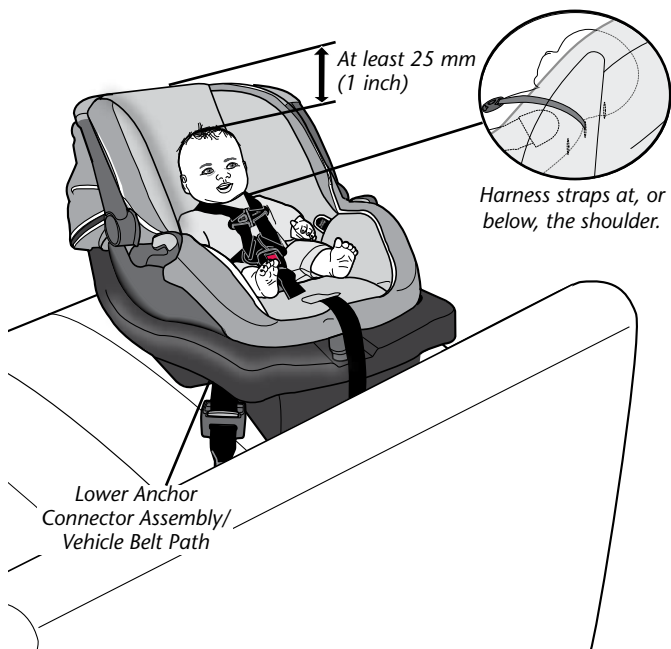

Installation Checklist

1. Secure convenience base to the vehicle seat.

- ✓ Convenience base is securely installed with lower anchor connector assembly (shown) (pages 20-26).

OR

- ✓ Convenience base is securely installed with vehicle seat belt (pages 28-33).

IMPORTANT: A properly secured convenience base does **NOT** move more than 25 mm (1 inch) from side-to-side or from front-to-back **at the lower anchor connector assembly/vehicle belt path.**

- ✓ Convenience base is adjusted so that level indicator is in correct color zone for your child (pp. 21 and 28).
- ✓ If necessary, a towel/small blanket is rolled up and placed beneath the front edge of the base for additional leveling (p. 34).

2. Secure child to the carrier. Refer to p. 41.

- ✓ Harness straps are at, or below, shoulder level (p. 44).
- ✓ Both buckle tongues are fastened (p. 41).
- ✓ Chest clip is connected and positioned at armpit level (p. 42).
- ✓ Harness straps are snug against the child and you should not be able to pinch the harness (p. 42).
- ✓ Crotch strap is snug against the child but **NOT** under the child's bottom (p. 46).
- ✓ Waist straps are snug against the child but **NOT** under the child's legs (p. 48).

3. Check your work.

- ✓ The convenience base does **NOT** move more than 25 mm (1 inch) from side-to-side or from front-to-back **at the lower anchor connector assembly/vehicle belt path.**
- ✓ The base is level when level indicator is in the correct color zone for your child (pp. 21 and 28).
- ✓ The handle is in **Position 3** (U.S. models **ONLY**), or **Position 1** (Canadian models **ONLY**) (p. 35).



Installing the Convenience Base with the Lower Anchor Connector Assembly

⚠ WARNING

- This lower anchor connector assembly is intended to be used **ONLY** as described in these instructions. Serious injury or death may result from misuse.
- In addition to these instructions, read and follow your vehicle owner's manual regarding installation of the child restraint and LATCH. If there is a discrepancy, follow your vehicle owner's manual.
- **ONLY** use for securing convenience base to vehicle lower anchor bars.
- **NEVER** attach two lower anchor assembly connectors to one vehicle lower anchor bar.
- **NEVER** use the vehicle seat belts when using the lower anchor connector assembly. Using both together can cause slack in a sudden stop or crash.
- When not in use, the lower anchor connector assembly should be securely stored in the storage area located under the convenience base (see page 53). Keep out of reach of children.
- **ALWAYS** be sure that the lower anchor connectors are fully engaged onto the vehicle lower anchor bars by pulling hard on the lower anchor connector assembly harness. If they are not totally engaged, the lower anchor connector assembly system will not secure your child restraint. Serious injury or death may result.
- **DO NOT** use this child restraint if it moves more than 25 mm (1 inch) side-to-side or front to back at the vehicle belt path. Serious injury or death may result from poor installation. If you can not tightly secure the child restraint, try again or move it to another location.
- This child restraint **MUST** face the rear of the vehicle.
- The carrier **MUST** be locked firmly into the base. Check by lifting up on the carrier.
- **NEVER** use this child restraint in the forward-facing position.

1

Before you begin, be sure the vehicle is on a level surface.

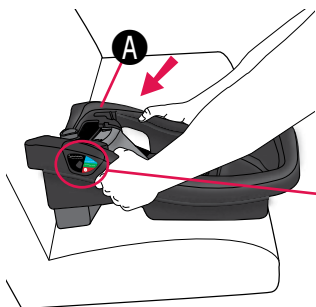

Using your full weight, push the base **A** into the vehicle seat and check the level indicator **B**.

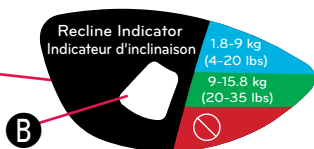

**Blue: 1.8 - 9 kg
(4 - 20 lbs)**

**Green: 9 - 15.8 kg
(20 - 35 lbs)**

White indicator line **MUST** be in the correct color zone for your child.

Note: NEVER allow white indicator line to appear in red zones.

The Leveling Foot that comes with your child restraint will be one of the following types (2a or 2b).

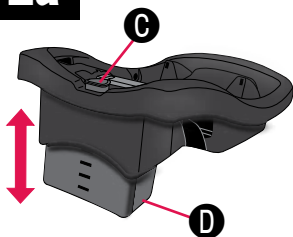
2a

Recline base until white indicator line is in the correct color zone for your child.

Turn adjustment knob **C** to raise or lower the adjustment foot **D**.

2b

Note: If you need to use the leveling foot, follow these steps.

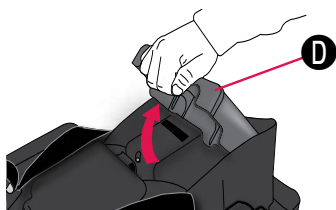

Turn base over and rotate leveling foot **D** up, as shown.

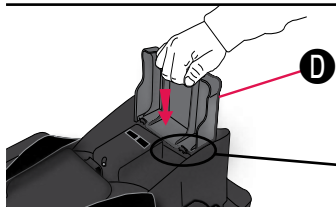

Push leveling foot **D** down until the locking tabs **E** snap in place, as shown.



Base shown with leveling foot extended.

Note: To store the leveling foot, follow these steps.

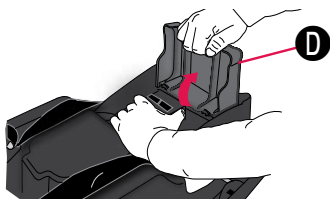

Turn base over. While holding the base down with one hand, rotate the leveling foot **D** to disengage the locking tabs.

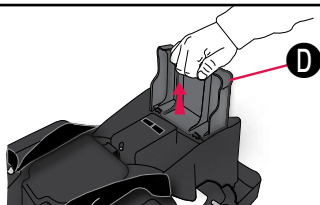

Pull leveling foot **D** up.

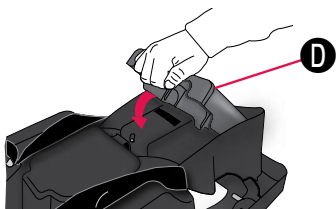

Rotate leveling foot **D** to stored position.



Base shown with leveling foot in stored position.

3

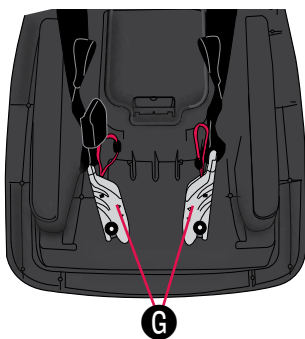
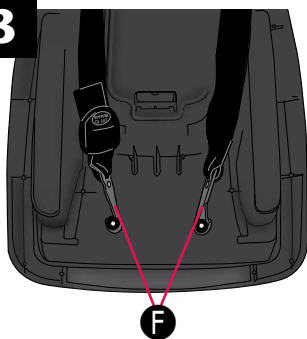

Turn the convenience base upside down. Remove both lower anchor hooks **F**, or clips **G**.

The Lock-Off that comes with your child restraint will be one of the following types (4a or 4b).

The Lock-Off provides a way to lock the child restraint without needing to lock your vehicle seat belt.

4a



Open One Step Lock-Off

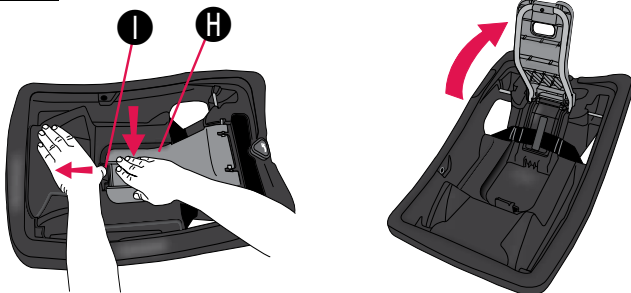

Turn the convenience base right side up. Push down on Lock-Off **H** while pushing back on Lock-Off Release Tab **I**. Lift the Lock-Off up to reveal the belt path.

4b

Open Two Step Lock-Off

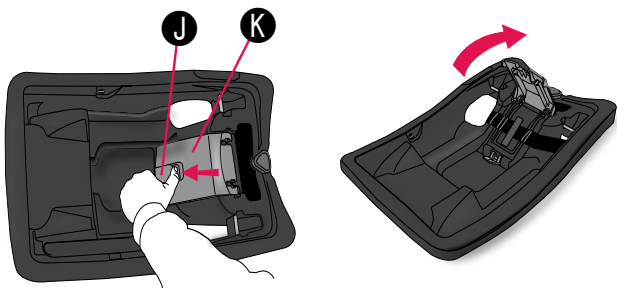

Turn the convenience base right side up. Lift the Lock-Off Release Tab **J**. Lift the Lock-Off **K** up to reveal the belt path.



5

Know Your Lower Anchor Connector Assembly

The lower anchor connector assembly that comes with your child restraint will be one of the types below.

SecureRight

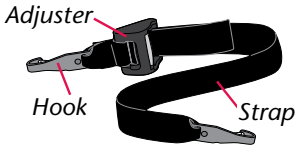

Quick Connector

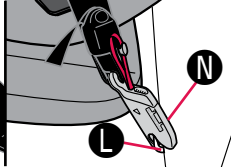
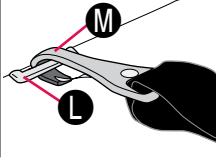
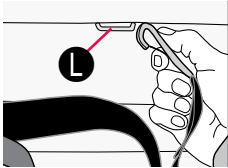
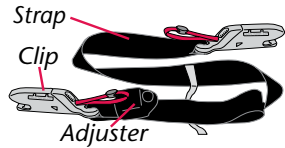

Refer to your vehicle owner's manual to locate the lower anchor bars **L** on your vehicle seat. Attach the right hook **M**, or clip **N**, to the right anchor bar **L** and the left hook, or clip, to the left anchor bar. **DOUBLE CHECK** that the lower anchor connector hook, or clip, is fully engaged by pulling hard on the lower anchor connector strap.

6



Using your full weight, push the base into the vehicle seat, while pulling up on the strap to remove all slack from the lower anchor connector assembly.

7a

Close One Step Lock-Off

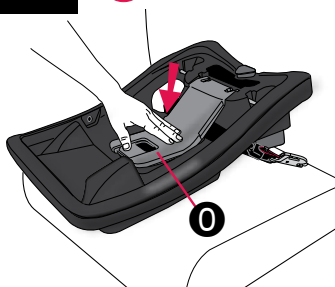

Route any excess lower anchor connector assembly harness strap across the belt path so it will be under the Lock-Off. Close the Lock-Off **O** until it clicks into place.

Note: If unable to close the Lock-Off, loosen the lower anchor connector assembly, and try again.

7b

Close Two Step Lock-Off

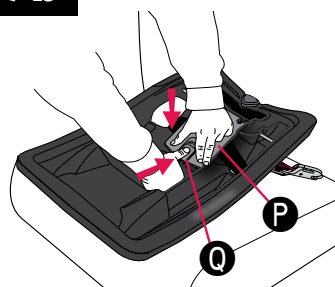

Route any excess lower anchor connector assembly harness strap across the belt path so it will be under the Lock-Off. Close the Lock-Off. While holding the Lock-Off **P** down, close the Lock-Off Release Tab **Q** until it clicks into place, and is flush with the Lock-Off.

Note: If unable to close the Lock-Off, loosen the lower anchor connector assembly, and try again.

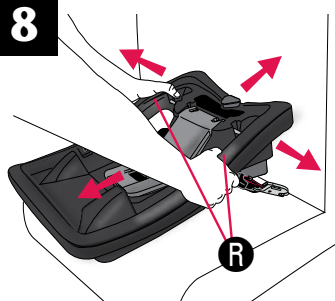
8

⚠ WARNING

Make sure the lower anchor connector assembly harness is tight. Grab the base at the areas **R**, as shown. If you can move the base more than 25 mm (1 inch) side-to-side or front to back, the harness is not tight enough. You will need to try again, or find another location for your convenience base.

This page is intentionally blank.

Installing the Convenience Base with the Vehicle Seat Belt

⚠ WARNING

- The carrier **MUST** be locked firmly into the convenience base. Check by lifting up on the carrier.
- **NEVER** use this child restraint in the forward-facing position.
- The Lock-Off built into the base of this child restraint, provides a way to lock the child restraint without needing to lock your vehicle seat belt.

1

Before you begin, be sure the vehicle is on a level surface.

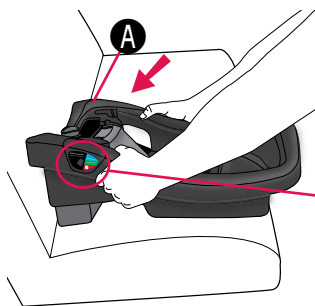

Using your full weight, push the base **A** into the vehicle seat and check the level indicator **B**.

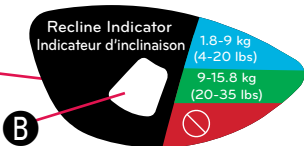

**Blue: 1.8 - 9 kg
(4 - 20 lbs)**

**Green: 9 - 15.8 kg
(20 - 35 lbs)**

White indicator line **MUST** be in the correct color zone for your child.

Note: NEVER allow white indicator line to appear in red zones.

The Leveling Foot that comes with your child restraint will be one of the following types (2a or 2b).

2a

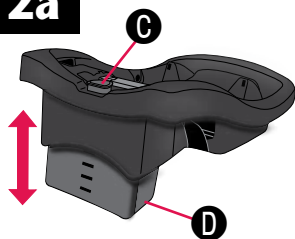

Recline base until white indicator line is in the correct color zone for your child.

Turn adjustment knob **C** to raise or lower the adjustment foot **D**.

2b

Note: If you need to use the leveling foot, follow these steps.

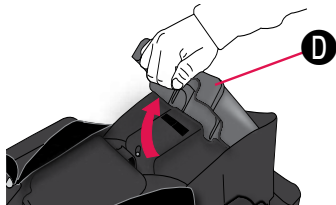

Turn base over and rotate leveling foot **D** up, as shown.

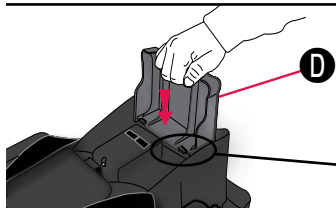

Push leveling foot **D** down until the locking tabs **E** snap in place, as shown.



Base shown with leveling foot extended.

Note: To store the leveling foot, follow these steps.

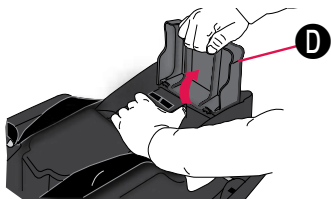

Turn base over. While holding the base down with one hand, rotate the leveling foot **D** to disengage the locking tabs.

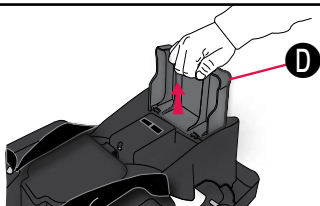

Pull leveling foot **D** up.

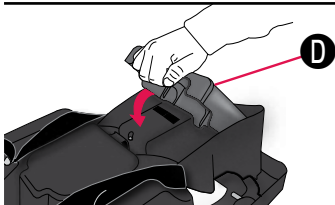

Rotate leveling foot **D** to stored position.



Base shown with leveling foot in stored position.

The Lock-Off that comes with your child restraint will be one of the following types (3a or 3b).

3a

Open One Step Lock-Off

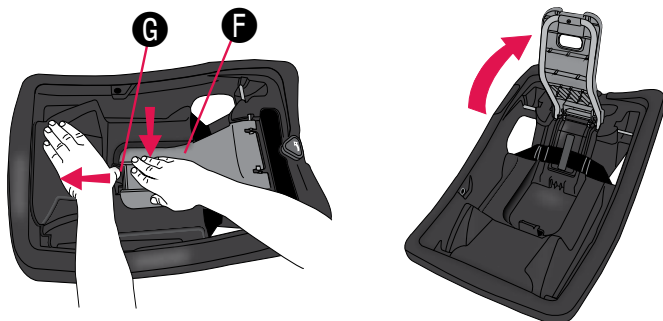

Push down on Lock-Off **F** while pushing back on Lock-Off Release Tab **G**. Lift the Lock-Off up to reveal the belt path.

3b

Open Two Step Lock-Off

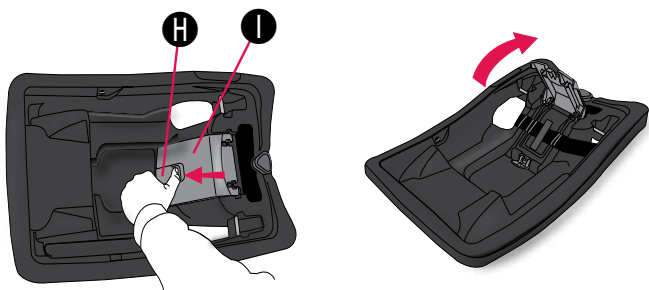

Lift the Lock-Off Release Tab **H**. Lift the Lock-Off **I** up to reveal the belt path.

4

Secure the base to your vehicle seat by routing the vehicle seat belt through the openings **J** on the sides of the base.

LAP AND SHOULDER BELT

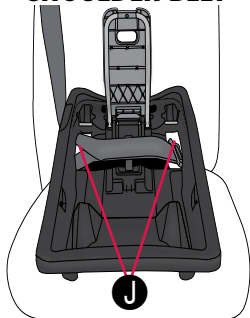

LAP BELT

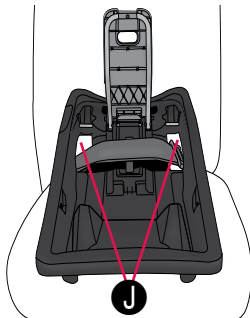
**5**

LAP AND SHOULDER BELT

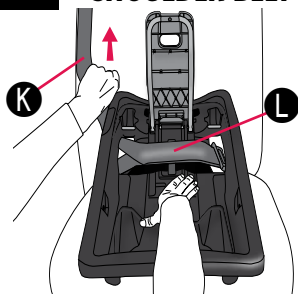

Pull the shoulder belt **K** tightly to remove all slack from the lap portion of the belt **L**, at the same time use your full weight to push down on the base.

LAP BELT

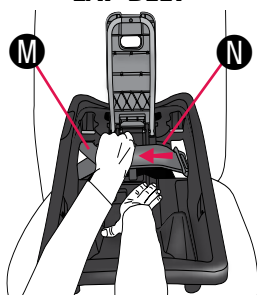

Pull the seat belt **M** tightly to remove all slack from the lap portion of the belt **N**, at the same time use your full weight to push down on the base.

Note: Route any excess vehicle belt across the belt path so it will be under the Lock-Off.

Note: If seat belt Stop Button **O** interferes with the Lock-Off, shift base to the left or right in order to prevent interference.

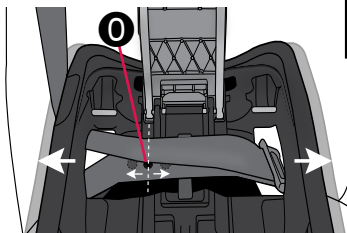

6a

Close One Step Lock-Off

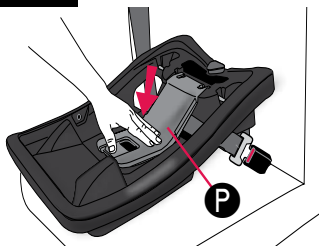

Close the Lock-Off **P** until it clicks into place.

6b

Close Two Step Lock-Off

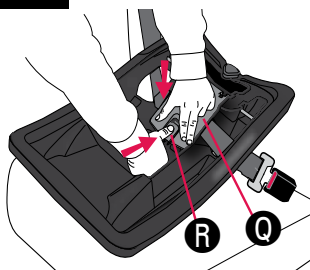

Close the Lock-Off. While holding the Lock-Off **Q** down, close the Lock-Off Release Tab **R** until it clicks into place and is flush with the Lock-Off.

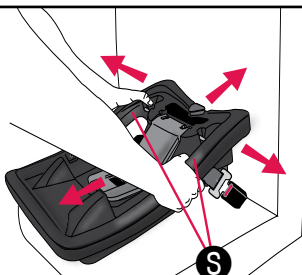
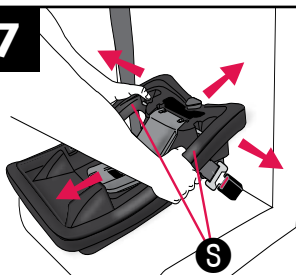
7

⚠ WARNING

*Make sure the vehicle belt is tight. Grab the base at the areas **S**, as shown. If you can move the base more than 25 mm (1 inch) side-to-side or front to back the vehicle belt is not tight enough. You will need to try again, or find another location for your convenience base.*

Placing the Carrier in the Base

1

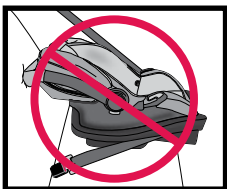
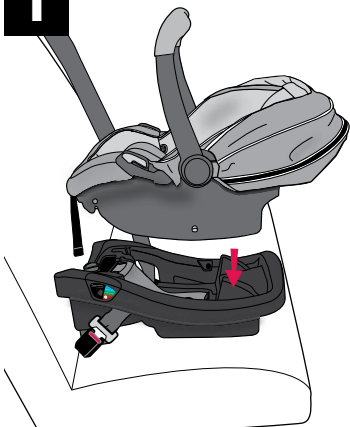

Secure the carrier to the base by placing it into the base and pressing down on the front and back.

The carrier *MUST* be locked firmly into the base. Check by lifting up on the carrier handle to make sure it's locked in place.

2

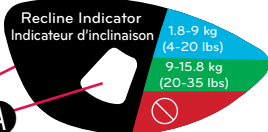
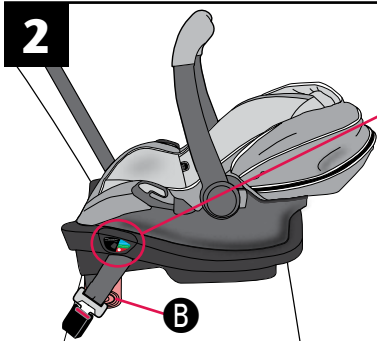

**Blue: 1.8 - 9 kg
(4 - 20 lbs)**

**Green: 9 - 15.8 kg
(20 - 35 lbs)**

The level indicator **A** must be in the correct color zone for your child. If you have fully adjusted the convenience base and the level indicator is still not level, use a tightly rolled towel or small blanket **B** beneath the front edge of the base.

IMPORTANT: Infants may have difficulty breathing when in a sitting position. Make sure they recline enough for their head to lie back comfortably and safely. Failure to properly recline the child restraint could increase the child's risk of serious injury or death.

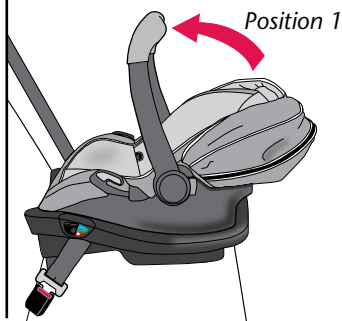
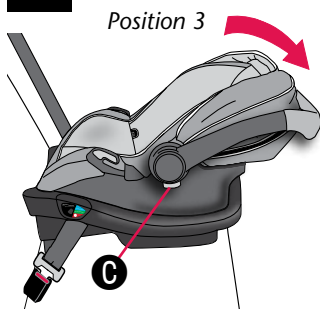
3**U.S. Models ONLY****Canadian Models ONLY**

Squeeze both handle releases **C** and move the handle to the travel position: **Position 3** (U.S. models **ONLY**) or **Position 1** (Canadian models **ONLY**) until it locks in place.

Releasing the Carrier from the Base

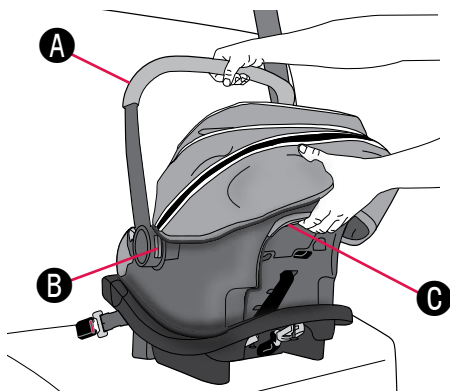

Move the handle **A** to **Position 1** (Carry) by squeezing in on both handle releases **B** and rotating the handle until it locks into place above the carrier. Squeeze the carrier release handle **C** while lifting up the carrier.

Proper Installation **WITHOUT** the Convenience Base

Child Requirements

Weight: 1.8 – 15.8 kg (4 – 35 lbs)

Height: 43 – 81 cm (17 – 32 inches)

Top of head must be at least 25 mm (1 inch)
below the top of the child restraint seat back.

*Harness straps at, or
below, the shoulder.*

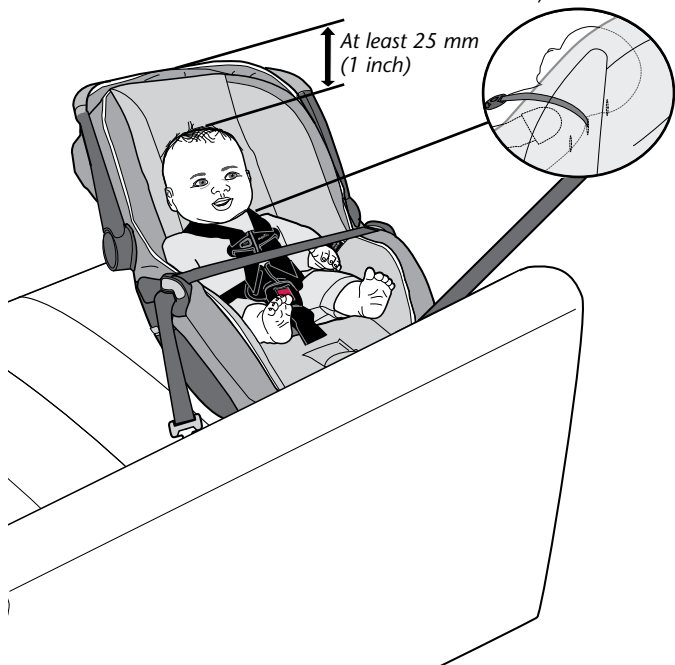

Installation Checklist

1. Place the child in the carrier.

- ✓ The child's back and bottom are flat against the back and bottom surfaces of the carrier.
- ✓ Top of child's head is at least 25 mm (1 inch) below the top of the child restraint seat back.

2. Secure child to the carrier. Refer to p. 41.

- ✓ Harness straps are at, or below, shoulder level (p. 44).
- ✓ Both buckle tongues are fastened (p. 41).
- ✓ Chest clip is connected and positioned at armpit level (p. 42).
- ✓ Harness straps are snug against the child and you should not be able to pinch the harness (p. 42).
- ✓ Crotch strap is snug against the child, but **NOT** under the child's bottom (p. 46).
- ✓ Waist straps are snug against the child, but **NOT** under the child's legs (p. 48).

3. Secure child restraint to the vehicle seat.

- ✓ Carrier is securely installed with vehicle seat belt (p. 38).
- ✓ The shoulder strap portion of the seat belt is lying across the vehicle seat back (p. 38).
- ✓ Locking clip is installed, if necessary (p. 40).
- ✓ The level line is level with ground (p. 38).
- ✓ The handle is in **Position 3** (U.S. models **ONLY**), or **Position 1** (Canadian models **ONLY**) (p. 39)
- ✓ If necessary, a towel/small blanket is rolled up and placed beneath the front edge of the carrier so the child's head lies back comfortably (p. 40).

4. Check your work.

- ✓ To properly protect your child, the carrier **MUST NOT** move more than 25 mm (1 inch) from side-to-side or from front-to-back **at the vehicle belt path.**

Installing the Carrier without the Convenience Base

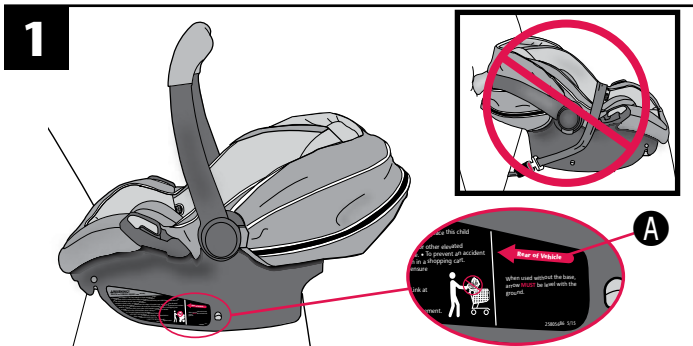

After securing the infant, place the restraint into your vehicle. Adjust the restraint so that the level line **A** is level with the ground.

Note: Generally, the center rear seating position is the safest. **This infant restraint *MUST* face the rear of the vehicle.**

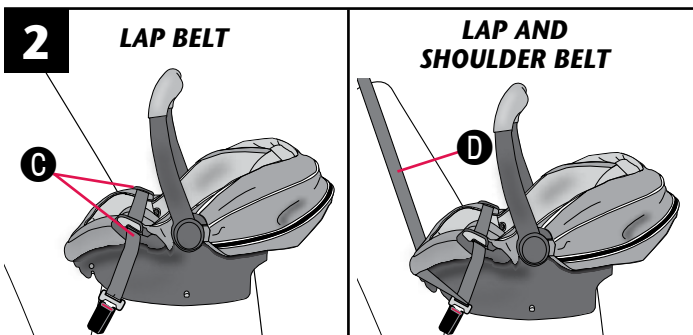

Route **ONLY** the **lap portion** of the vehicle seat belt through the vehicle belt slots **C** on the carrier. In vehicles with a lap **and** shoulder belt **D**, **DO NOT** route the shoulder belt through the belt slots. Instead, let it lay across the vehicle seat back, as shown.

IMPORTANT: Some ELR vehicle belts can be switched so that they lock when tightened. It may not be necessary to use a locking clip in these situations. To install a locking clip, refer to p. 40. Refer to the vehicle owner's manual to determine which type of belt retractor is in the vehicle.

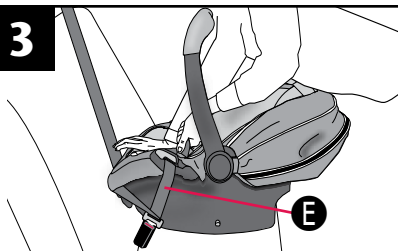
3**TIP!**

Push down on the bottom of the seat using your full weight.

⚠ WARNING

- **NEVER** use this child restraint in forward-facing position.
- **DO NOT** use this carrier if it moves more than 25 mm (1 inch) side-to-side or front to back at the vehicle belt path. Serious injury or death may occur. Move the child restraint to another seating location, or try to tighten the vehicle belt again.

The vehicle belt **E** must be as tight as possible. Put your full weight into the seat as you tighten the vehicle belt. If you can move the child restraint more than 25 mm (1 inch) side-to-side or front to back at the vehicle belt path, the vehicle belt is not tight enough, and you need to try again.

4**U.S. Models ONLY****Canadian Models ONLY**

Position 3

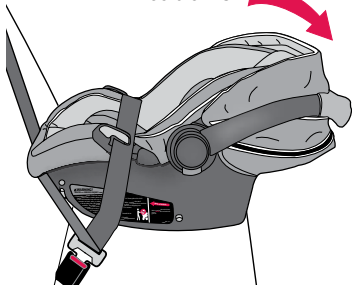

Position 1

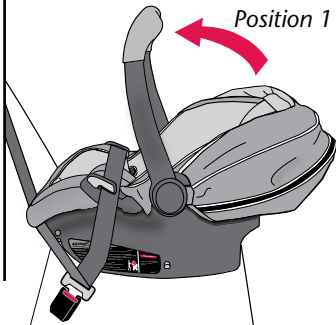

Squeeze both handle releases **C** and move the handle to the travel position: **Position 3** (U.S. models **ONLY**) or **Position 1** (Canadian models **ONLY**) until it locks in place.

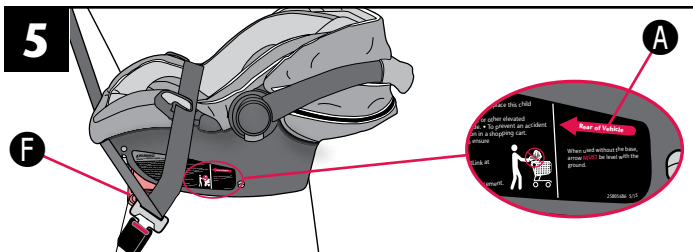

If the level line **A** is not level with the ground, use a tightly rolled towel or small blanket **F** beneath the front edge of the child restraint to provide enough recline for an infant's head to lie back comfortably.

IMPORTANT: Infants may have difficulty breathing when in a sitting position. Make sure they recline enough for their head to lie back comfortably and safely. Failure to properly recline the child restraint could increase the child's risk of serious injury or death.

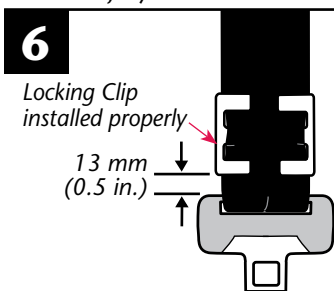

Install Locking Clip (not included), if necessary.

If your vehicle was built **prior to model year 1996**, and has a lap/shoulder belt that is equipped with an emergency locking retractor (ELR) AND sliding latch plate, you **MUST** use a Locking Clip.

Check your vehicle owner's manual to identify which vehicle belt system is in your vehicle. If your vehicle is **model year 1996 or newer**, it likely has a vehicle belt system that can be locked when tightened, and will not require use of a Locking Clip.

Consult your vehicle owner's manual before installing a locking clip.

If your vehicle requires a Locking Clip, please call ParentLink at 1-800-233-5921 (U.S.) or 1-937-773-3971 (Canada), or 01-800-706-12-00 (Mexico) to obtain a Locking Clip and instructions on how to install and use it.

⚠️ WARNING

- Remove Locking Clip from vehicle seat belt when not used with a child restraint, or the vehicle seat belt will not properly restrain an adult or child. Serious injury could occur.

Securing the Child in the Carrier



Place the baby into the carrier. Baby's bottom and back should be flat against the seat. If there is a gap, baby will not be comfortable.

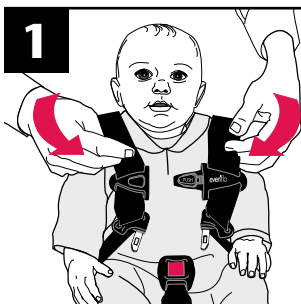

Slide each harness strap over the child's shoulders.

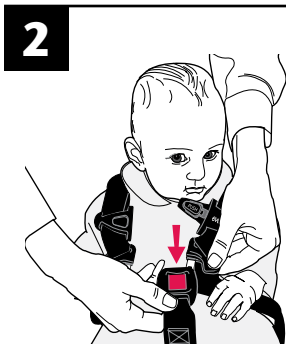

Insert the buckle tongues into the buckle. Pull up on the harness straps to ensure the buckle tongues are engaged.

IMPORTANT: The crotch strap should **ALWAYS** be as close as possible to, but **NEVER** under, the child's bottom. Adjust the crotch strap if necessary (p. 46).

The waist straps should **ALWAYS** be as close as possible to, but **NEVER** under, the child's legs. Adjust the waist straps if necessary (p. 48).

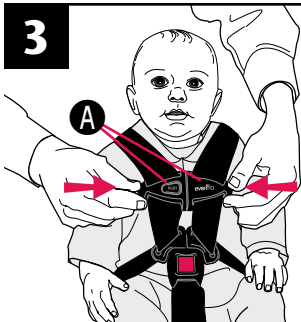
3

Align the two sides of the chest clip **A** and snap them together. The chest clip must be positioned at armpit level.

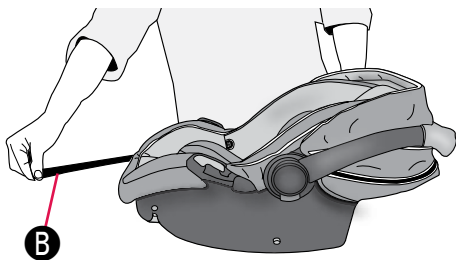

The harness straps must be snug against the child. A snug strap should not allow any slack. It lies in a relatively straight line without sagging. It does not press on the child's flesh or push the child's body into an unnatural position. Check the harness straps near the shoulders for slack. You should **NOT** be able to pinch the harness (see illustration). Adjust as needed.

4

To tighten the harness straps, pull the harness adjuster strap **B** on front of the restraint, as shown.

Removing the Child from the Carrier

1

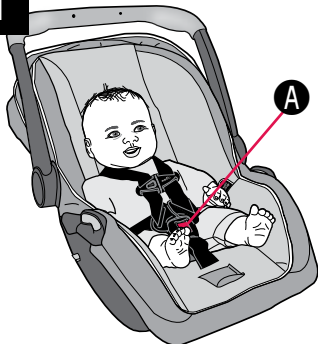

Press the red buckle release **A**, and remove the buckle tongues.

2

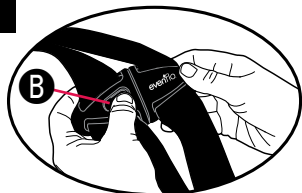

Push the release button **B** and pull the chest clip apart.

3

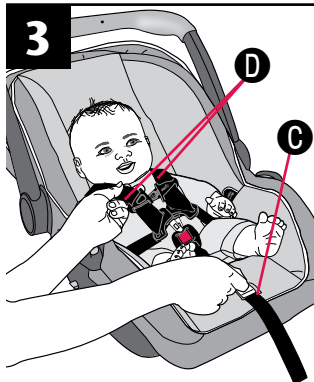

To loosen the harness straps, press the harness release button **C** while pulling upward on the harness straps **D**.

Changing the Harness Position

As your child grows, you will need to change the harness strap position so they are routed through the slots closest to the child's shoulders. The shoulder harness straps should **ALWAYS** be as close as possible to, but **NEVER** above the child's shoulders.

1

Loosen the harness straps **A** by pressing the harness release button **B** while pulling on the straps.

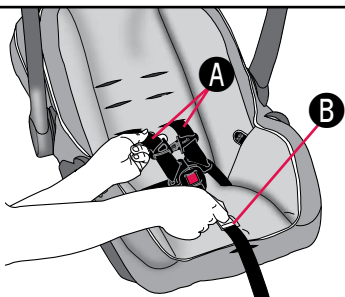

2

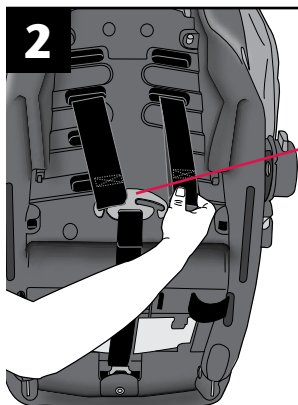

Slide the harness strap off of the splitter plate **C**.

3

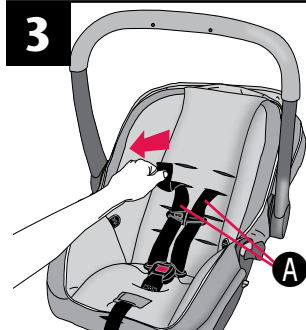

Pull both harness straps **A** through the front of the child restraint.

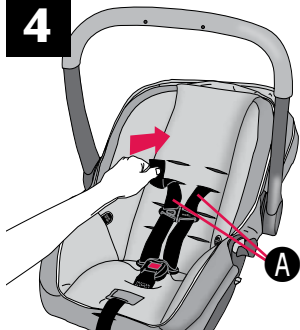
4

Insert both harness straps **A** into the new harness position slots.

IMPORTANT: When inserting harness straps through the slots in the seat pad, make sure you route them correctly through their corresponding slots in the seat shell.

5

Attach the harness straps **A** to the splitter plate **C**.

IMPORTANT: Make sure both harness straps are installed **completely** on the splitter plate, as shown.

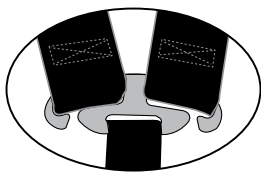
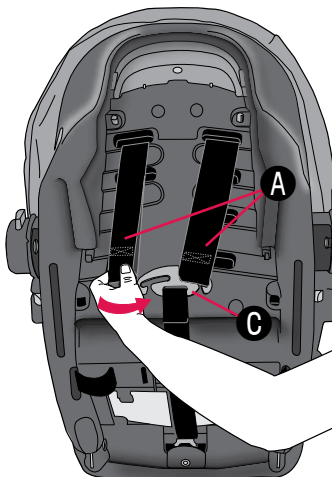
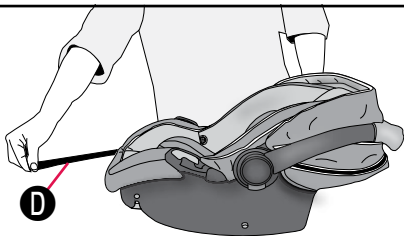
**6**

Tighten the harness straps by pulling the adjustment strap **D** on front of the restraint.

Note: Final adjustment of the harness straps must be completed with the baby in the child restraint.

Changing the Crotch Strap Position

As your child grows, you will need to change the crotch strap position so that it is in the slot closest to your child. The crotch strap should **ALWAYS** be as close as possible to, but **NEVER** under, the child's bottom.

Crotch Strap in the Rear Slot

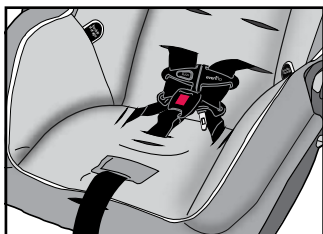
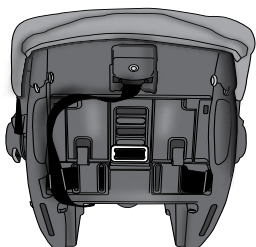

Crotch Strap in the Middle Slot

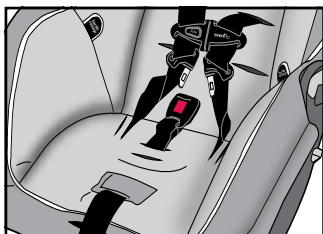
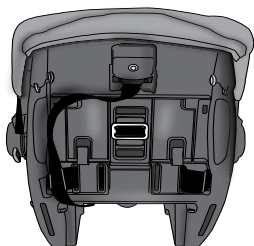

Crotch Strap in the Front Slot

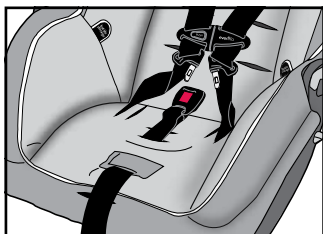
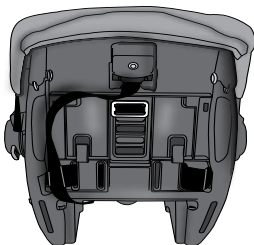

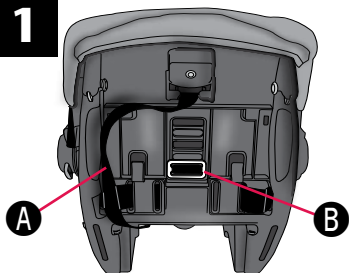
1

To reposition crotch strap, loosen the harness straps (p. 43) and move the strap **A** out of the way.

Remove the crotch strap anchor **B** from its position on the bottom of the carrier, and push the anchor up through the slot to the top of the seat.

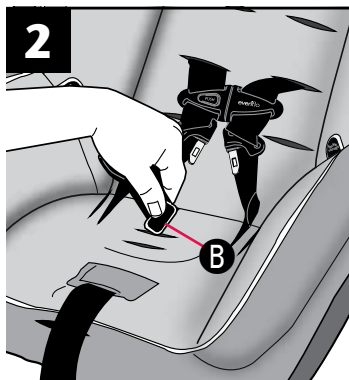
2

Insert the crotch strap anchor **B** into the slot that is the *closest* to the child, but **NEVER** under the child's bottom.

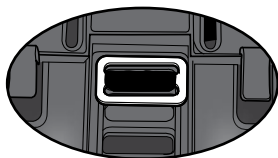

Make sure the anchor is completely through and is lying flat against the bottom of the seat. Pull up on the crotch strap to make sure it is securely fastened.

Changing the Waist Strap Position

As your child grows, you will need to change the waist strap position so that it is in the slot closest to your child. The waist strap should **ALWAYS** be as close as possible to, but **NEVER** under, the child's legs.

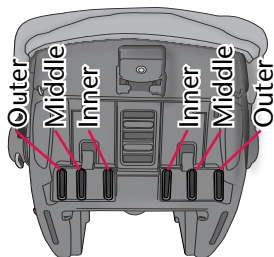

Approximate Child Size: Waist Strap Position:

Small	1.8 - 2.7 kg (4 - 6 lbs)	Inner
Medium	2.7 - 9 kg (6 - 20 lbs)	Middle
Larger	9 - 15.8 kg (20 - 35 lbs)	Outer

1

To reposition waist straps, loosen the harness straps **A** by pressing the harness release button **B** while pulling on the harness straps.

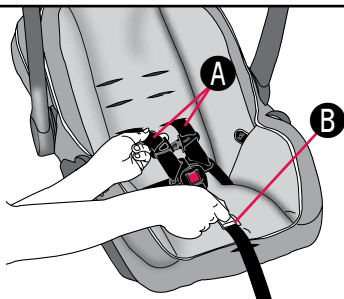

2

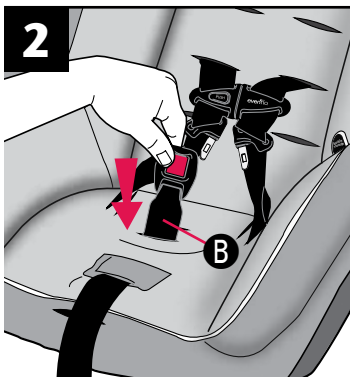

Push the croch strap **B** through the slot in the seat pad

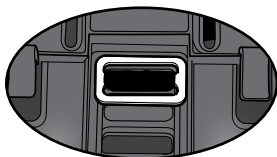

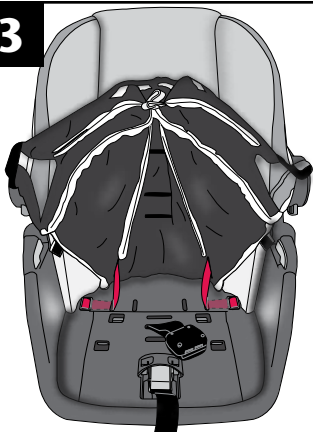
3

Unhook the front of the child restraint's seat pad and move it out of the way to expose the waist strap slots and anchors.

Remove the waist strap anchor **C** from its position on top of the seat, and push the anchor down through the slot to the bottom of the seat. Then push anchor up through the slot to the top of the seat pad. Repeat on other side.

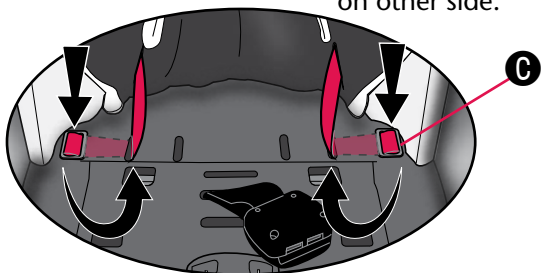
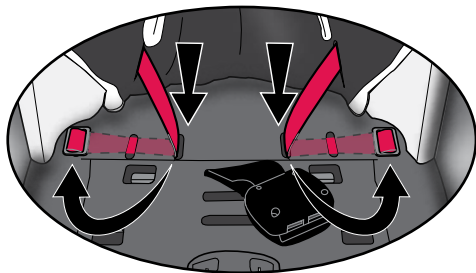
**4**

Push the anchor down through the appropriate slot to the bottom of the seat. Then push anchor up through the appropriate slot to the top of the seat.

Note: See images (pp. 50 and 51) to find the appropriate waist strap slots for your child's size.

Small size baby

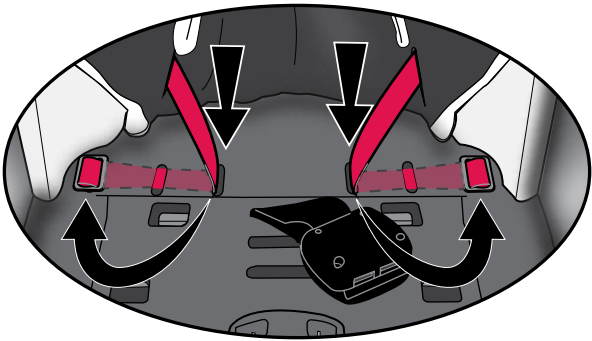

Medium size baby

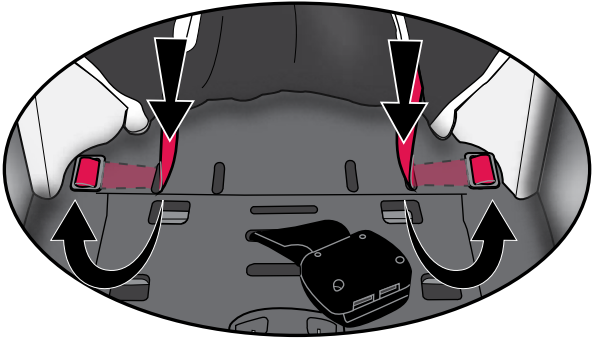

Larger size baby

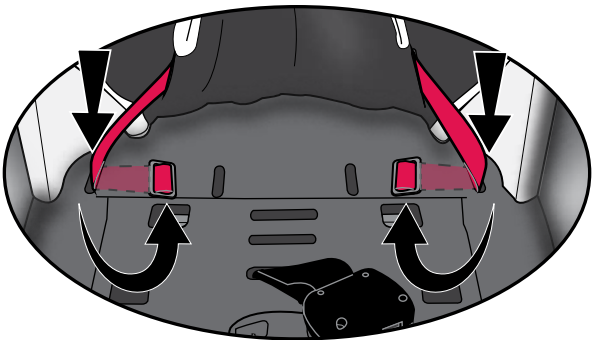

Small size baby

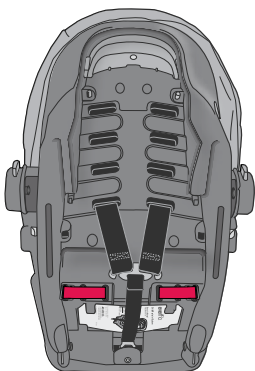

Medium size baby

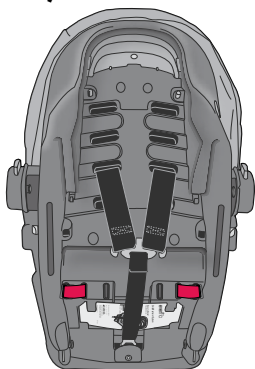
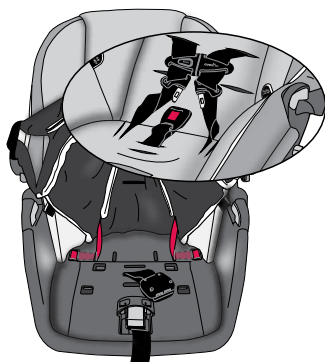

Larger size baby

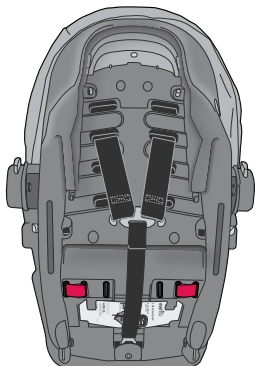
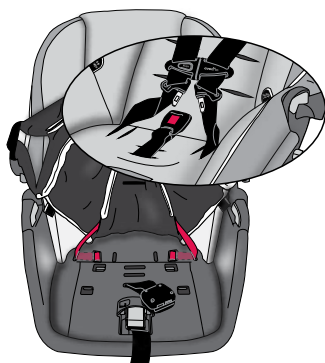

Removing the Lower Anchor Connector Assembly

1



Tilt and slide the adjuster to loosen the lower anchor connector assembly.

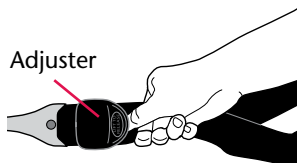

Press the adjuster release button to loosen the lower anchor connector assembly

Or

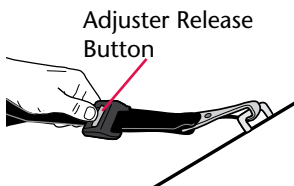

2

The lower anchor connector that comes with your child restraint will be one of the types below.

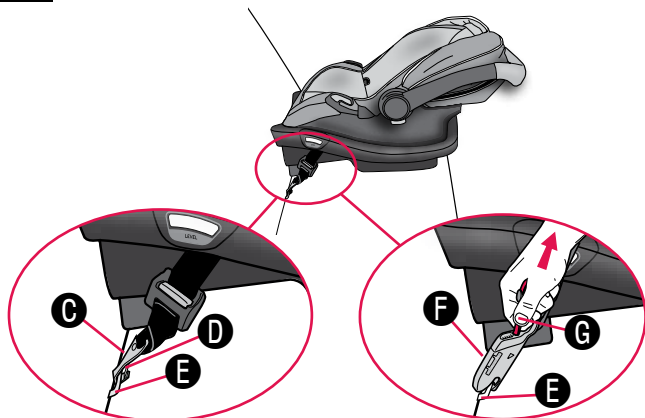

To remove the hook **C**, press the tab **D** and twist, then remove from anchor **E**.

To remove the clip **F**, pull the red release strap **G** and remove clip from anchor **E**.

3

When the lower anchor connector assembly is not in use, you **MUST** securely store it in the area provided on the bottom of the base.

Make sure the lower anchor connector assembly strap is routed through the belt path **H** on top of the base. Then attach the hooks **I** or clips **J** to the posts **K** located on each side of the storage area beneath the base.

A loose lower anchor assembly connector harness and hook may injure your child.

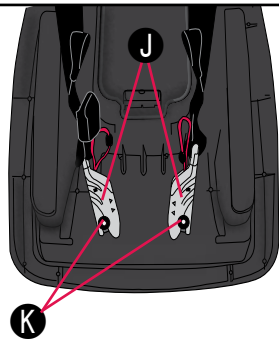
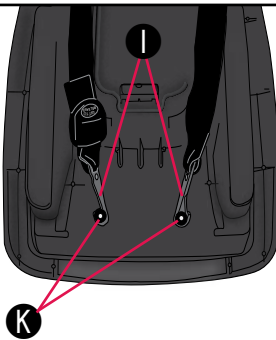
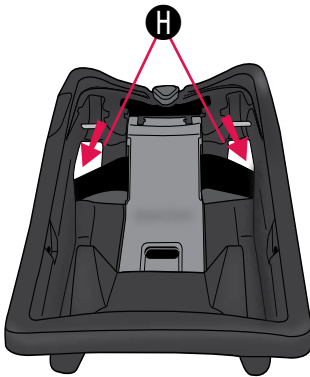

Using as an Infant Carrier

Secure the child in the carrier by following “Securing the Child in the Carrier” on page 41.

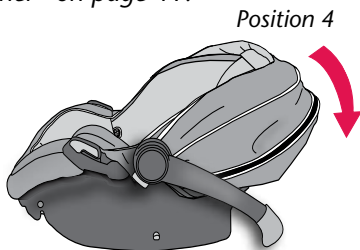

To use as a stand: Squeeze both handle releases and rotate the handle to **Position 4** (Stand) until it locks into place and the carrier rests on a level surface.

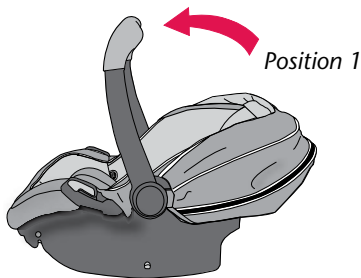

To use as a carrier: Squeeze both handle releases and rotate the handle to **Position 1** (Carry) until it locks into place. Carry at your side, using the handle as shown.

IMPORTANT

The harness **MUST** be securely buckled **at all times**.



⚠ WARNING

- **NEVER** place this carrier near the edges of counter tops, tables, or other high surfaces. The child's movements can cause the carrier to slide and fall.
- **NEVER** leave the child in this carrier when the harness straps are loose or undone. Children have **STRANGLED** in loose or partially buckled harness straps. Fully restrain the child even when carrier is outside the vehicle.



- **NEVER** place the carrier in any position in a shopping cart. The carrier may fall from the cart and your child may be injured.



- **DO NOT** carry on your hip.

Securing Your Child Restraint in Aircraft

The Federal Aviation Administration (FAA) recommends that you secure your child for air travel in an appropriate child restraint based on your child's weight and size. Turbulence can happen with little or no warning. When turbulence occurs, **the safest place for your child is in a properly installed child restraint, not in an adult's lap or on the aircraft seat with its seat belt.** Keeping your child in a child restraint during the flight will help ensure your family arrives safely at your destination.

The FAA recommends that a child weighing:

- more than 18 kg (40 lbs) use an aircraft seat belt;
- less than 9 kg (20 lbs) use a rear-facing child restraint; and
- from 9 to 18 kg (20 to 40 lbs) use a forward-facing child restraint.

Please note that these FAA recommendations may vary from those applicable to the use of your child restraint in a motor vehicle.

IMPORTANT

You must use the internal harness when installing the child restraint in aircraft.

*Before installing the child restraint, make sure the **aircraft seat is in a fully upright position.***

DO NOT *use the convenience base when installing child restraint in aircraft.*

Installing Carrier without Convenience Base in Aircraft

1

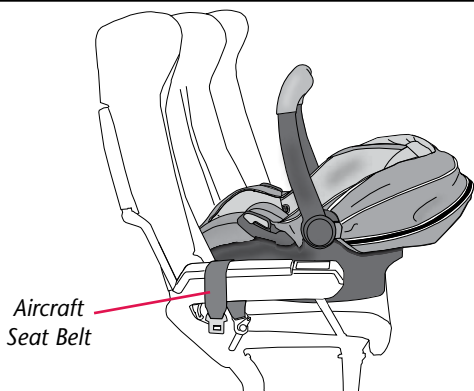

Place the child restraint on the aircraft seat **rear-facing**, as shown above.

2

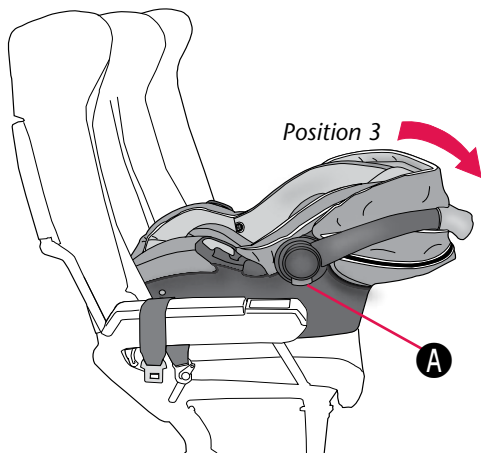

Squeeze both handle releases **A** and move the handle to *Position 3*.

Installing Carrier without Convenience Base in Aircraft

3

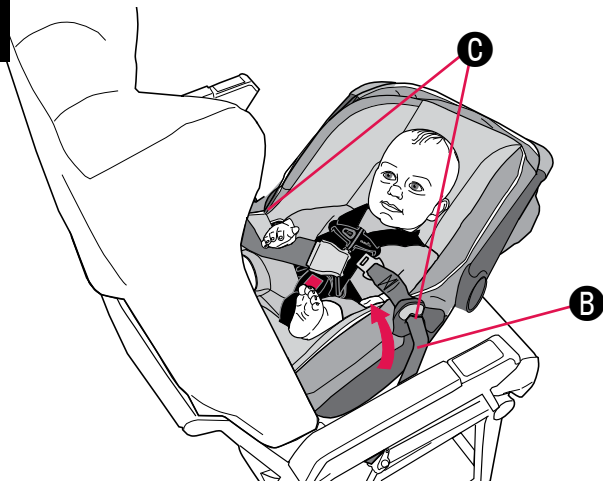

Route the aircraft seat belt **B** through the belt slots **C** on the carrier, as shown above.

4

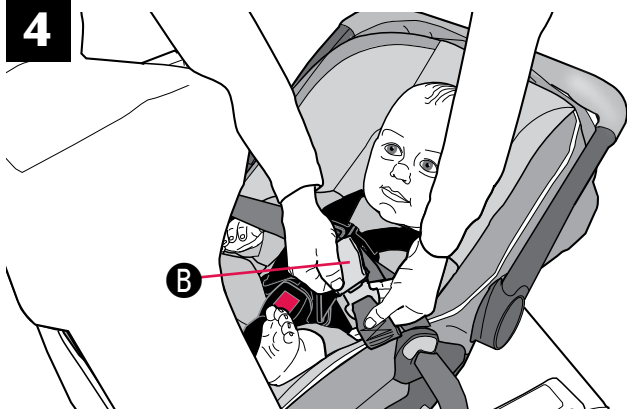

Fasten the aircraft seat belt **B**.

Installing Carrier without Convenience Base in Aircraft

5

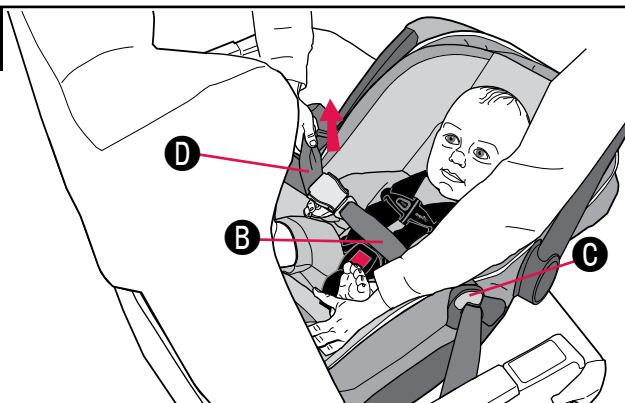

The aircraft seat belt **B** must be as tight as possible. Route the excess seat belt strap **D** back through the belt slots **C**, as shown above. Using your full weight, push the child restraint firmly onto the aircraft seat while pulling on the excess seat belt strap to tighten.

Check your work. Try to move the child restraint in all directions. If you can move the child restraint more than 25 mm (1 inch) side-to-side or front to back at the belt path **C**, the aircraft seat belt **B** is not tight enough, and you **MUST** install again until the seat belt is tight.

6

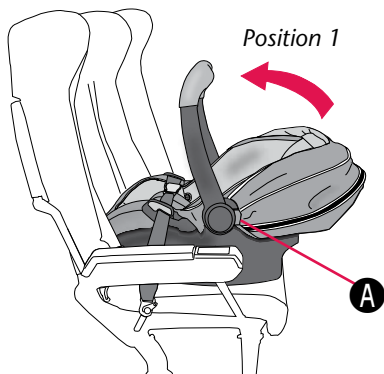

Squeeze both handle releases **A** and move the handle to *Position 1*.

Installing the Canopy

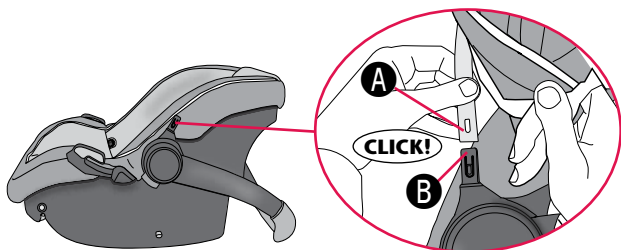

Insert front canopy end **A** into the holder **B** until it clicks into place. Repeat on the other side.

Installing the Accessories

1

Not available on all models. Styles may vary.

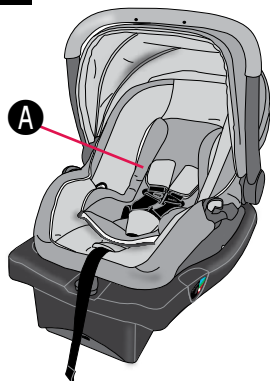

The optional head pillow and/or body pillow **A** is used to help support your child by placing it in the restraint, as shown.

IMPORTANT: Support the child's head. Infants may have difficulty breathing when in a sitting position. Using additional padding or pillows behind the infant's head, or failure to properly recline the child restraint could increase the child's risk of serious injury or death.

2

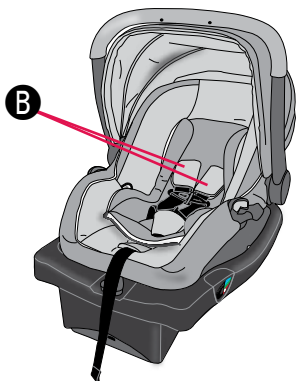

To remove the harness covers **B**, follow steps for Changing the Harness Position (p. 44). After Step 3, slide harness covers off harness straps. Continue with Steps 4 through 6.

To reattach harness covers **B**, follow steps for Changing the Harness Position (p. 44). After Step 3, slide harness covers over harness straps. Continue with Steps 4 through 6.

IMPORTANT: The shoulder harness straps should **ALWAYS** be as close as possible to, but **NEVER** above the child's shoulders.

3

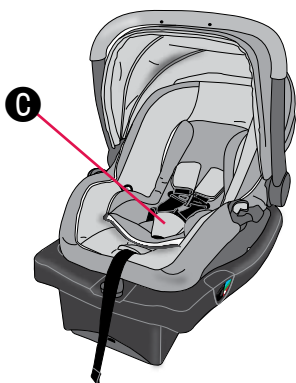

To remove the buckle cover **C**, press the red buckle release under the buckle cover, and remove buckle tongues. Pull buckle cover off the buckle.

To reattach the buckle cover **C** press the red buckle release, and remove buckle tongues. Push the buckle cover onto the buckle.

IMPORTANT: The crotch strap should **ALWAYS** be as close as possible to, but **NEVER** under, the child's bottom. Adjust the crotch strap if necessary (p. 46).

Removing the Seat Pad

- Move handle to Position 4 (p. 17).
- Unfasten chest clip and crotch buckle (p. 43).
- Remove crotch buckle cover (p. 61).
- Remove harness straps from splitter plate on back of child restraint (p. 44).
- Pull harness straps to front of child restraint (p. 44).
- Remove harness covers and body pillow (p. 61).

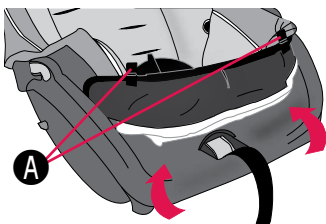

Remove two J-clips **A** from front of child restraint and pull bottom of seat pad off front of child restraint.

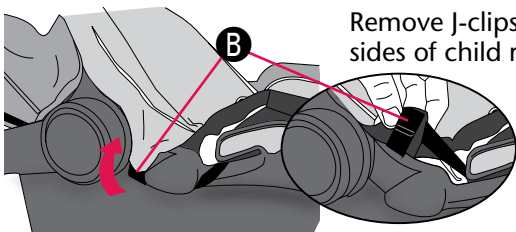

Remove J-clips **B** from both sides of child restraint.

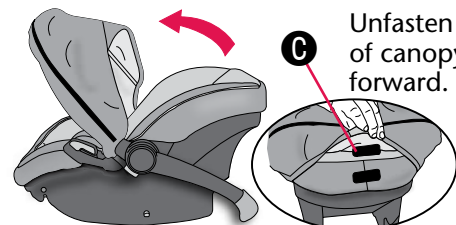

Unfasten Velcro® **C** on back of canopy and pull canopy forward.

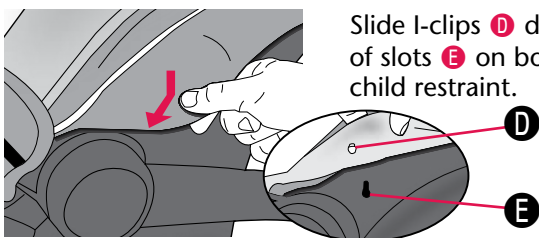

Slide I-clips **D** down and out of slots **E** on both sides of child restraint.

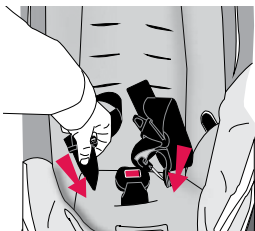

Push both harness straps through seat pad.

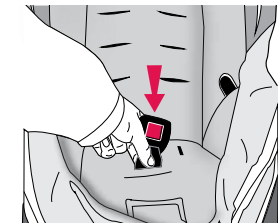

Push crotch buckle through seat pad.

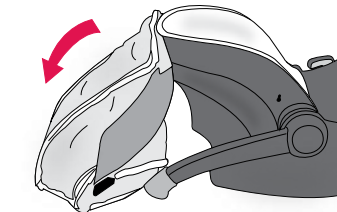

Push seat pad up and over child restraint.

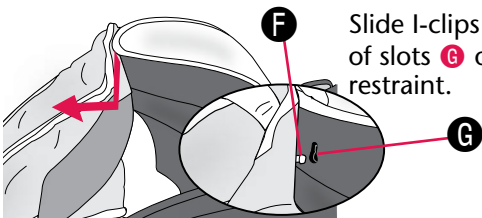

Slide I-clips **F** down and out of slots **G** on top of child restraint.

To replace seat pad, reverse these steps.

Note: Make sure to place harness strap in the same harness and waist slots as before. Make sure to place the crotch buckle in the same slot as before.

IMPORTANT: Make sure both harness straps are installed **completely** on the splitter plate, as shown (p. 45).

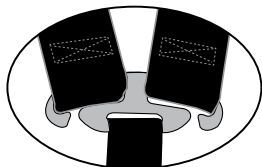

Replacement Parts

Not available on all models. Styles may vary.

To order replacement parts you can order online at **www.evenflo.com** or contact Evenflo. When you contact us, please have the product model number and date of manufacture (found on the back of the child restraint).



Buckle Cover



Head Foam
(Canada only)



EPS Foam



Harness Cover



Head Pillow

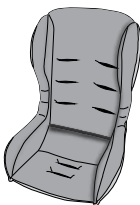

Body Pillow

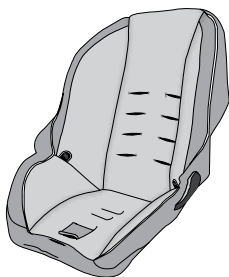

Seat pad

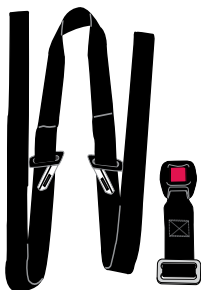

Harness System



Canopy



Lower Anchor
Connector Assembly

Or



Lower Anchor
Connector Assembly
with Quick
Connectors™

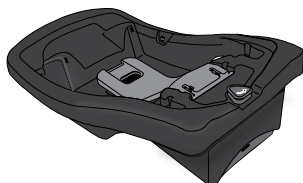

Accessory Base

Proper Disposal of this Child Restraint

At the end of this child restraint's useful life, Evenflo encourages you to dispose of it properly. Most of the components in this child restraint are recyclable.

1. Remove all fabric and padding.
2. Remove all screws and disassemble the restraint.
3. Recycle all plastic/foam parts and discard the rest.

If your local recycling center won't accept the padding, you may dispose of it in the landfill.

Note: Evenflo uses recycled materials in the manufacturing process whenever possible but never for components that are critical for safety.

To prevent injury due to hidden damage, lost instructions, outdated technology, etc., discontinue use of this restraint after the expiration date on the label or if it has been involved in a crash.

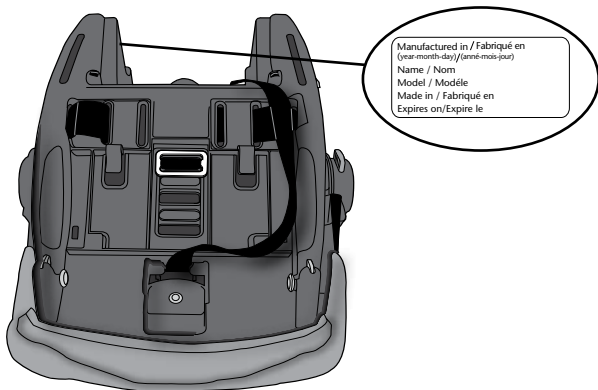

Limited Warranty

For a period of 90 days from the original purchase of this Product, Evenflo warrants to the original end user (“Purchaser”) this Product (including any accessories) against defects in material or workmanship. Evenflo’s sole obligation under this express limited warranty shall be, at Evenflo’s option, to repair or replace any Product that is determined to be defective by Evenflo and determined to be covered by this warranty.

Repair or replacement as provided under this warranty is the exclusive remedy of the Purchaser. Proof of purchase in the form of a receipted invoice or bill of sale evidencing that the Product is within the warranty period must be presented to obtain warranty service. This express limited warranty is extended by Evenflo ONLY to the original Purchaser of the Product and is not assignable or transferable to subsequent purchasers or end users of the Product. For warranty service, contact Evenflo’s ParentLink Consumer Resource Center at (800) 233-5921 (U.S.), (937) 773-3971 (Canada), or **www.evenflo.com**.

EXCEPT TO THE EXTENT PROHIBITED BY APPLICABLE LAW, ANY IMPLIED WARRANTY OF MERCHANTABILITY OR FITNESS FOR A PARTICULAR PURPOSE ON THIS PRODUCT IS HEREBY DISCLAIMED. EVENFLO SHALL NOT BE LIABLE FOR ANY INCIDENTAL, CONSEQUENTIAL, SPECIAL OR PUNITIVE DAMAGES OF ANY KIND FOR BREACH OF THE EXPRESS LIMITED WARRANTY ON THIS PRODUCT, OR ANY WARRANTY IMPLIED BY OPERATION OF LAW. OTHER THAN THE EXPRESS LIMITED WARRANTY SET FORTH ABOVE, THERE ARE NO OTHER WARRANTIES THAT ACCOMPANY THIS PRODUCT AND ANY ORAL, WRITTEN OR ANY OTHER EXPRESS REPRESENTATION OF ANY KIND IS HEREBY DISCLAIMED.

ParentLink®

answers. advice. affirmation.™

www.evenflo.com

USA: 1-800-233-5921, 8 AM – 5 PM E.T.

Canada: 1-937-773-3971

México: 01-800-706-12-00